

LUXEON F Family

Micro footprint package for design flexibility and high light output

LUXEON F are high-power, 1.9mm x 2.3mm LEDs that are specifically designed to support automotive functional intelligence systems, including advanced forward lighting systems, light guide, and matrix applications. LUXEON F are tested and binned at application conditions – 85°C for reliability, performance and lifetime in all exterior lighting applications. LUXEON F meets both SAE and ECE color specifications and provides finer granularity than existing systems.

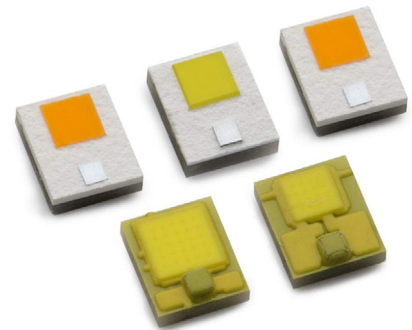

FEATURES AND BENEFITS

Small form factor for dense packing ability and design flexibility

Undomed package allows for precise optical control

Low V_f and industry's lowest thermal resistance enables smaller heatsinks or smaller designs

HIEC/PAS 62707-1 White LED color binning

PRIMARY APPLICATIONS

Adaptive Lighting

Daytime Running Lights

Front Fog

Headlight

- High/Low Beam
- Cornering
- Position

Turn

Table of Contents

General Information	2
Product Nomenclature	2
LED Lifetime Characteristics	3
Environmental Compliance	3
Product Performance and Characteristics Guides	4
Optical Characteristics	5
Electrical Characteristics	6
Absolute Ratings	7
JEDEC Moisture Sensitivity	8
Mechanical Dimensions and Solder Pad Design	9
Characteristic Curves	11
Light Output Conversion Table, Direct Current to Mono Pulse	12
Typical Radiation Pattern LUXEON F PC Amber & Plus PC Typical Radiation Pattern LUXEON F Cool White	35
Typical Radiation Pattern LUXEON F ES Cool White	36
Typical Radiation Pattern LUXEON F Plus Cool White & Premium Cool White	36
Emitter Pocket Tape Packaging	37
Emitter Reel Packaging	38
Emitter Laser Marking	39
Automotive Product Binning and Labeling	40
LUXEON F Cool White Family Bin Structure	42
Forward Voltage Bins	45

General Information

Product Nomenclature

LUXEON F is tested and binned at 85°C DC Case Temperature, T_c . T_c is defined in Figure 1 (refer to LUXEON F Application Brief AB108 for additional details). Additional information regarding hot binning is available from your Lumileds Sales representative.

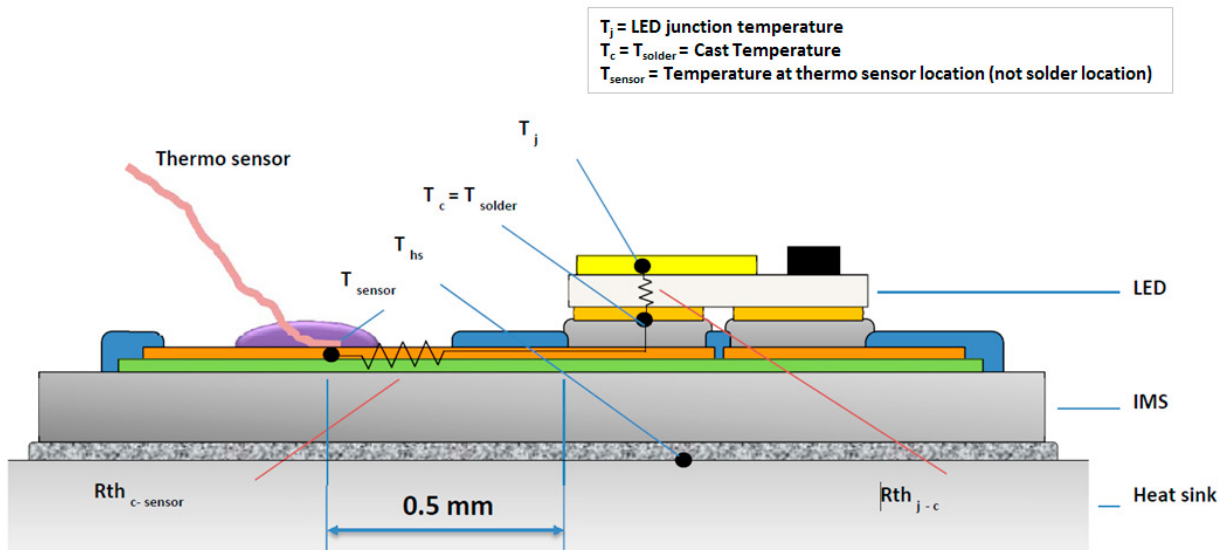

Figure 1. LUXEON F case temperature location on sample board.

The part number designation is explained as follows:

L F X H - **A B C** - **E F G H**

Where:

- L — designates LUXEON
- F — designates LUXEON F product family
- XH — designates hot binning
- A — designates color variant (C for cool white, L for PC Amber)
- B — designates die size (1 for 1mm², 2 for 2mm²)
- C — designates binning current/ maximum current (A for 350mA/700mA, B for 700mA/1000mA, C for 1000mA/1000mA and D for 1000mA/1500mA)
- E — reserved for future product offerings
- FGH — minimum luminous flux performance

LED Lifetime Characteristics

Lifetime for solid-state lighting devices (LEDs) is defined in terms of lumen maintenance—the percentage of initial light output remaining after a specified period of time—and light output failures such as shorts. These two degradation modes are both considered in Lumileds LED lifetime assessments.

This performance is based on independent test data, Lumileds historical data from tests run on similar material systems, and internal LUXEON reliability testing. Observation of design limits included in this data sheet is required in order to achieve these projected lifetimes.

Please contact your Lumileds sales representative for LED lifetime assessments for your operational conditions.

Environmental Compliance

Lumileds is committed to providing environmentally friendly products to the solid-state lighting market. LUXEON F is compliant to the European Union directives on the restriction of hazardous substances in electronic equipment, namely the RoHS and REACH directives. Lumileds will not intentionally add the following restricted material to the LUXEON F: lead, mercury, cadmium, hexavalent chromium, polybrominated biphenyls (PBB) or polybrominated diphenyl ethers (PBDE).

Product Performance and Characteristics Guides

Product Selection Guide for LUXEON F at Test Current, $T_c = 85^\circ\text{C}$ DC ^[3, 4]

Table 1.

Product	Color	Min. Performance at Binning Current		Typical Performance at Maximum Current		Part Number
		Luminous Flux (lm) ^[1]	Current (mA)	Luminous Flux (lm) ^[2]	Current (mA)	
LUXEON F	PC Amber	60	350	100	700	LFXH-L1A-0060
		70	350	120	700	LFXH-L1A-0070
		80	350	133	700	LFXH-L1A-0080
	Cool White	90	350	172	700	LFXH-C1A-0090
		100	350	186	700	LFXH-C1A-0100
		110	350	203	700	LFXH-C1A-0110
LUXEON F ES	Cool White	200	700	265	1000	LFXH-C2B-0200
		220	700	292	1000	LFXH-C2B-0220
		240	700	319	1000	LFXH-C2B-0240
LUXEON F Plus	PC Amber	130	1000	138	1000	LFXH-L1C-0130
		140	1000	145	1000	LFXH-L1C-0140
		150	1000	155	1000	LFXH-L1C-0150
		160	1000	164	1000	LFXH-L1C-0160
		170	1000	173	1000	LFXH-L1C-0170
	Cool White	200	1000	212	1000	LFXH-C1C-0200
		220	1000	230	1000	LFXH-C1C-0220
		240	1000	250	1000	LFXH-C1C-0240
		LUXEON F Premium	Cool White	200	1000	275
220	1000			299	1500	LFXH-C1D-0220
240	1000			325	1500	LFXH-C1D-0240

Notes for Table 1:

1. Lumileds maintains a tolerance of $\pm 6.5\%$ on flux measurements.
2. Typical luminous flux performance when device is operated within published operating conditions.
3. Case Temperature is defined in Figure 1; DC is defined as Direct Current.
4. Reference Flux is at 25°C MP (MP is defined as 20ms mono pulse). Reference flux is used for reference only and is not an additional specification.

Optical Characteristics

Optical Characteristics for LUXEON F at Test Current, $T_c = 85^\circ\text{C}$ DC

Table 2.

Product	Color	Test Current	Correlated Color Temperature or Dominant Wavelength			Typical Spectral Half-width ^[2] (nm) $\Delta\lambda_{1/2}$	Typical Temperature Coefficient of Dominant Wavelength (nm/ $^\circ\text{C}$) $\Delta\lambda_D / \Delta T_J$	Typical Total Included Angle ^[3] (degrees) $\theta_{0.90V}$	Typical Viewing Angle ^[4] (degrees) $2\theta_{1/2}$
			Min.	Typ.	Max.				
LUXEON F	PC Amber	350	588.8nm	590.7nm	592.6nm	75	0.06	164	118
	Cool White	350	5100K	5800K	6600K	-	-	164	118
LUXEON F ES	Cool White	700	5100K	5800K	6600K	-	-	164	118
LUXEON F Plus	PC Amber	1000	588.8nm	590.7nm	592.6nm	75	0.06	164	118
	Cool White	1000	5100K	5800K	6600K	-	-	164	118
LUXEON F Premium	Cool White	1000	5100K	5800K	6600K	-	-	164	118

Notes for Table 2:

1. CRI (Color Rendering Index) for white product types is 70 typical.
2. Spectral width at 1/2 of the peak intensity.
3. Total angle at which 90% of total luminous flux is captured.
4. Viewing angle is the off axis angle from lamp centerline where the luminous intensity is 1/2 of the peak value.

Electrical Characteristics

Electrical Characteristics for LUXEON F at Test Current, $T_c = 85^\circ\text{C}$ DC [4, 6]

Table 3.

Product	Color	Binning Current (mA)	Forward Voltage V_f [1] (V)			Typ. Dynamic Resistance [2] (Ω) R_D	Typical Temperature Coefficient of Forward Voltage [3] ($\text{mV}/^\circ\text{C}$) $\Delta V_f / \Delta T_j$	Typ. Thermal Resistance Junction to Case ($^\circ\text{C}/\text{W}$)	
			Min.	Typ.	Max.			$R\theta_{J-C}$	$R\theta^{[5]}_{J-C}$
LUXEON F	PC Amber	350	2.55	2.78	3.27	0.3	-0.2 to -4.0	4.3	5.6
	Cool White	350	2.55	2.77	3.27	0.3	-0.2 to -4.0	3.8	5.7
LUXEON F ES	Cool White	700	2.55	2.82	3.27	0.3	-0.2 to -4.0	2.4	3.7
LUXEON F Plus	PC Amber	1000	2.55	2.98	3.27	0.2	-0.2 to -4.0	4.8	5.7
	Cool White	1000	2.55	2.94	3.27	0.2	-0.2 to -4.0	4.2	5.5
LUXEON F Premium	Cool White	1000	2.55	2.94	3.27	0.2	-0.2 to -4.0	3.2	4.3

Notes for Table 3:

- Lumileds maintains a tolerance of $\pm 0.06\text{V}$ on forward voltage measurements.
- Dynamic resistance is the inverse of the slope in linear forward voltage model for LEDs. See Forward Voltage vs Forward Current Figures 19-28.
- Measured between $80^\circ\text{C} = T_c$ to $90^\circ\text{C} = T_c$ at $I_f =$ binning current.
- Case temperature is defined in Figure 1; DC is defined as direct current.
- Thermal resistance with wall plug efficiency included. Reference JESD51-51, JESD51-14, 4.1.3.
- LUXEON F is specified in terms of T_j . $T_j = T_c + V_f \cdot I_f \cdot R_{th}$.

Absolute Ratings

Table 4a. Absolute Ratings for LUXEON F

Parameter	PC Amber	Cool White
Minimum DC Forward Current (mA)	50	50
Maximum DC Forward Current (mA)	700	700
Maximum Junction Temperature	135°C	150°C
ESD Sensitivity ^[3]	8kV HBM, 400V MM	8kV HBM, 400V MM
Operating Case Temperature at Binning Current ^[1]	-40°C - 110°C	-40°C - 120°C
Storage Temperature	-40°C - 130°C	-40°C - 130°C
Soldering Temperature	Refer to AB108	Refer to AB108
Allowable Reflow Cycles	3	3
Autoclave Conditions	121°C at 2 ATM 100% Relative Humidity for 96 Hours Maximum	

Table 4b. Absolute Ratings for LUXEON F ES

Parameter	Cool White
Minimum DC Forward Current (mA)	50
Maximum DC Forward Current (mA)	1000
Maximum Junction Temperature	150°C
ESD Sensitivity ^[3]	8kV HBM, 400V MM
Operating Case Temperature at Binning Current ^[1]	-40°C - 120°C
Storage Temperature	-40°C - 130°C
Soldering Temperature	Refer to AB108
Allowable Reflow Cycles	3
Autoclave Conditions	121°C at 2 ATM 100% Relative Humidity for 96 Hours Maximum

Table 4c. Absolute Ratings for LUXEON F Plus

Parameter	PC Amber	Cool White
Minimum DC Forward Current (mA)	50	50
Maximum DC Forward Current (mA)	1000	1000
Maximum Junction Temperature	135°C	150°C
ESD Sensitivity ^[3]	8kV HBM, 400V MM	8kV HBM, 400V MM
Operating Case Temperature at Binning Current ^[1]	-40°C - 110°C	-40°C - 120°C
Storage Temperature	-40°C - 130°C	-40°C - 130°C
Soldering Temperature	Refer to AB108	Refer to AB108
Allowable Reflow Cycles	3	3
Autoclave Conditions	121°C at 2 ATM 100% Relative Humidity for 96 Hours Maximum	

Table 4d. Absolute Ratings for LUXEON F Premium

Parameter	Cool White
Minimum DC Forward Current (mA)	50
Maximum DC Forward Current (mA)	1500
Maximum Junction Temperature	150°C
ESD Sensitivity ^[3]	8kV HBM, 400V MM
Operating Case Temperature at Binning Current ^[1]	-40°C - 130°C
Operating Case Temperature at Maximum Current ^[1]	-40°C - 110°C
Storage Temperature	-40°C - 130°C
Soldering Temperature	Refer to AB108
Allowable Reflow Cycles	3
Autoclave Conditions	121°C at 2 ATM 100% Relative Humidity for 96 Hours Maximum

Notes for Table 4:

1. Proper current derating must be observed to maintain junction temperature below the maximum. LUXEON F LEDs driven at or above maximum LED case temperature may have shorter lifetime.
2. LUXEON F LEDs are not designed to be driven in reverse bias.
3. Measured using human body model and machine model (per AEC-Q101C).

JEDEC Moisture Sensitivity

Table 5.

Level	Floor Life	
	Time	Conditions
1	Unlimited	30°C / 85% RH

Mechanical Dimensions and Solder Pad Design

Dimensions for LUXEON F Cool White

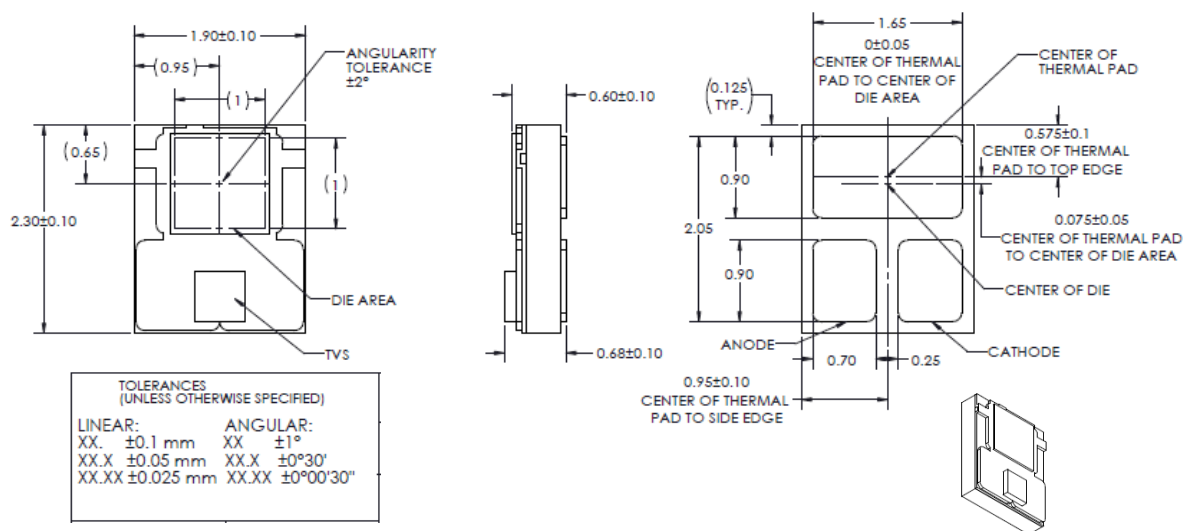

Figure 2. Mechanical Dimensions for LUXEON F Cool White.

Dimensions for LUXEON F ES Cool White

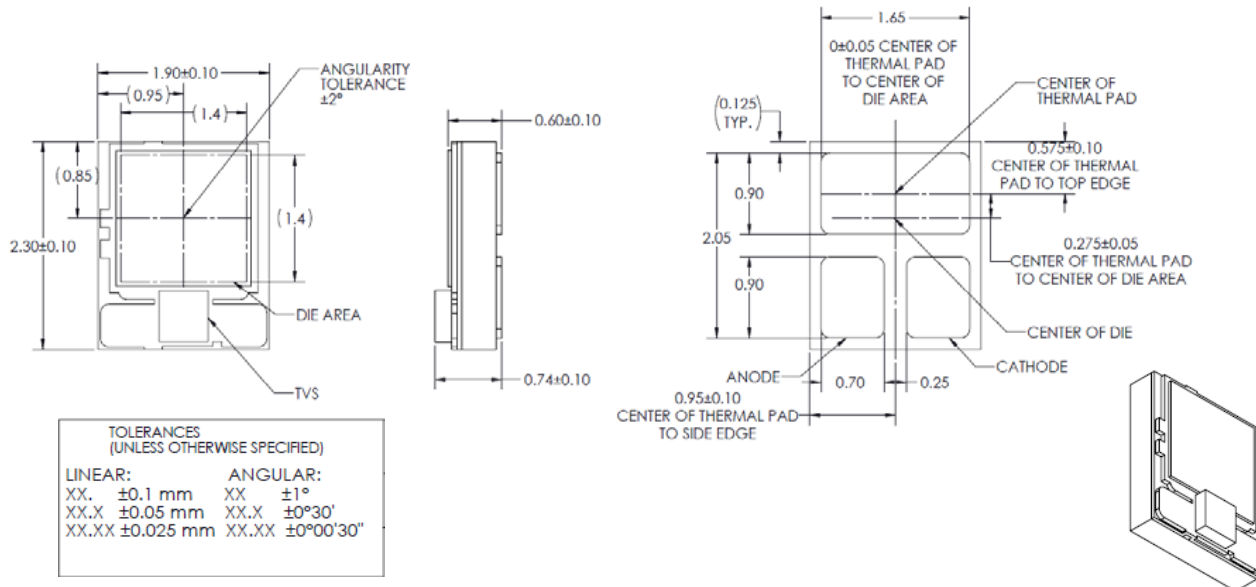

Figure 3. Mechanical Dimensions for LUXEON F ES Cool White.

Dimensions for LUXEON F (PC Amber), LUXEON F Plus (Cool White & PC Amber) and LUXEON F Premium

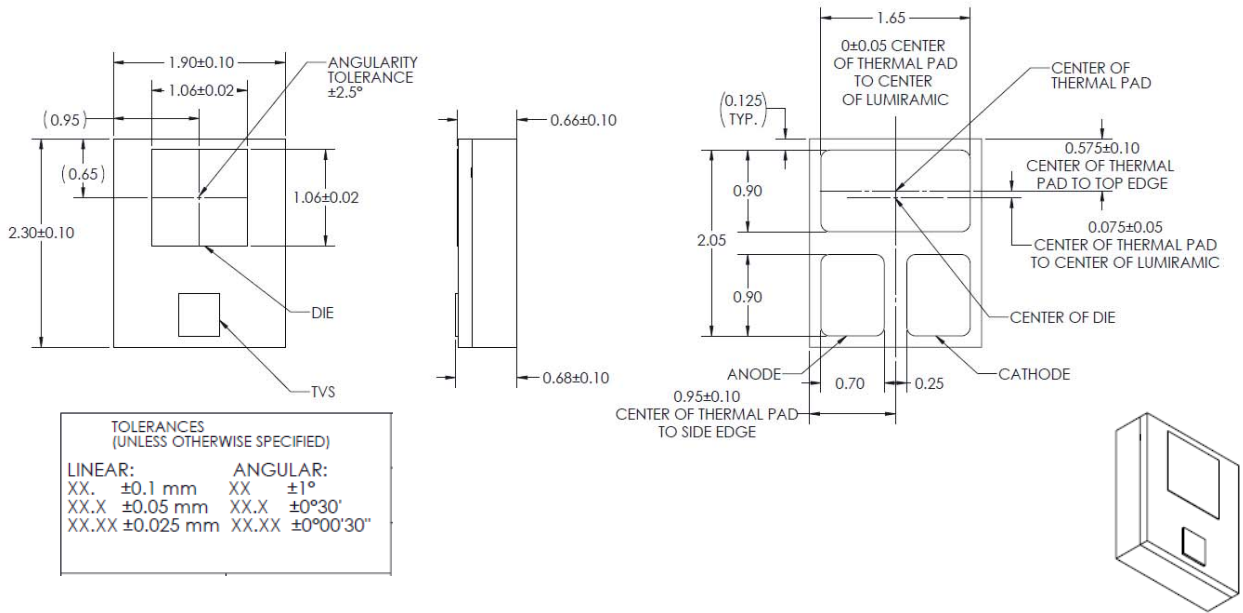

Figure 4. Mechanical Dimensions for LUXEON F (PC Amber), LUXEON F Plus (Cool White & PC Amber), LUXEON F Premium.

Notes for Figures 2, 3 & 4:

1. Drawings are not to scale
2. All dimensions are in millimeters.
3. The thermal pad is electrically isolated from Anode a Cathode contact pads.
4. Application Brief 108, AB108 provides extensive details on handling and assembly. The file is available at www.lumileds.com.

Characteristic Curves

Relative Spectral Distribution vs. Wavelength,
Case Temperature = 85°C; Test Current = 350mA

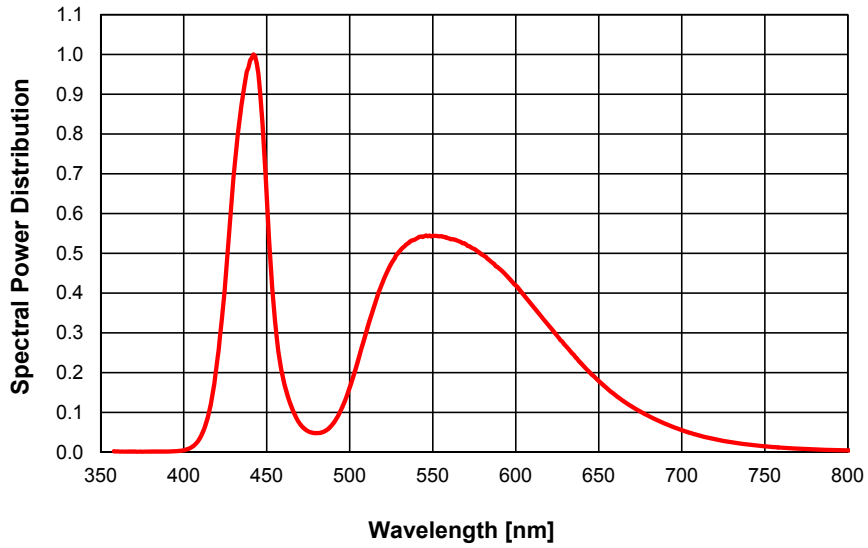

Figure 5. Emission color spectrum for LUXEON F and LUXEON F Plus (White), LUXEON F ES LUXEON F Premium.

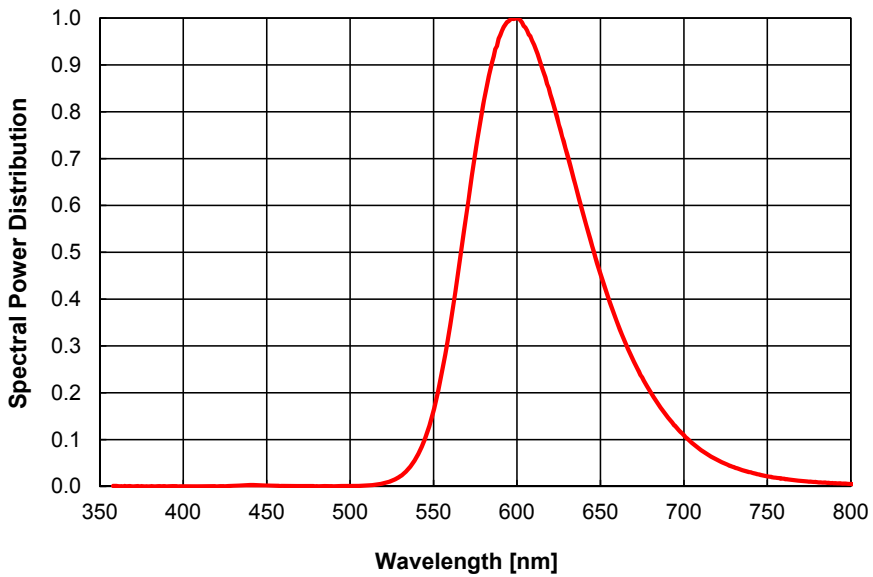

Figure 6. Emission color spectrum for LUXEON F and LUXEON F Plus (PC Amber).

Light Output Conversion Table, Direct Current to Mono Pulse

Table 6. 85°C DC to 25°C MP Flux Bin Conversion Factors for LUXEON F

Product	Color	Forward Current (mA)	Conversion Factor
LUXEON F	PC Amber	350	1.18
	Cool White	350	1.07
LUXEON F ES	Cool White	700	1.08
LUXEON F Plus	PC Amber	1000	1.36
	Cool White	1000	1.15
LUXEON F Premium	Cool White	1000	1.15

Note for Table 6:

1. Luminous flux bin conversion for LUXEON F emitters. Accuracy +/- 1%.

Light Output Characteristics. Case Temperature for LUXEON F PC Amber

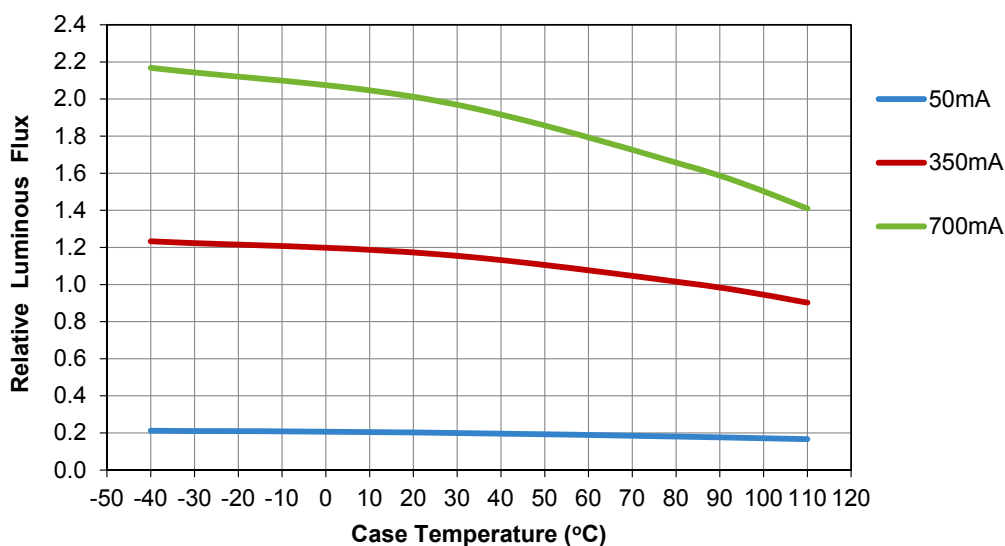

Figure 7. Relative luminous flux vs. case temperature LUXEON F PC Amber DC (350mA normalization).

Forward Current (mA)	Relative Luminous Flux vs. Thermal Pad Temperature for LUXEON F PC Amber
50	$y = -1.62E-6x^2 - 1.90E-4x + 2.07E-1$
350	$y = -1.35E-5x^2 - 1.25E-3x + 1.20E0$
700	$y = -2.75E-5x^2 - 3.12E-3x + 2.09E0$

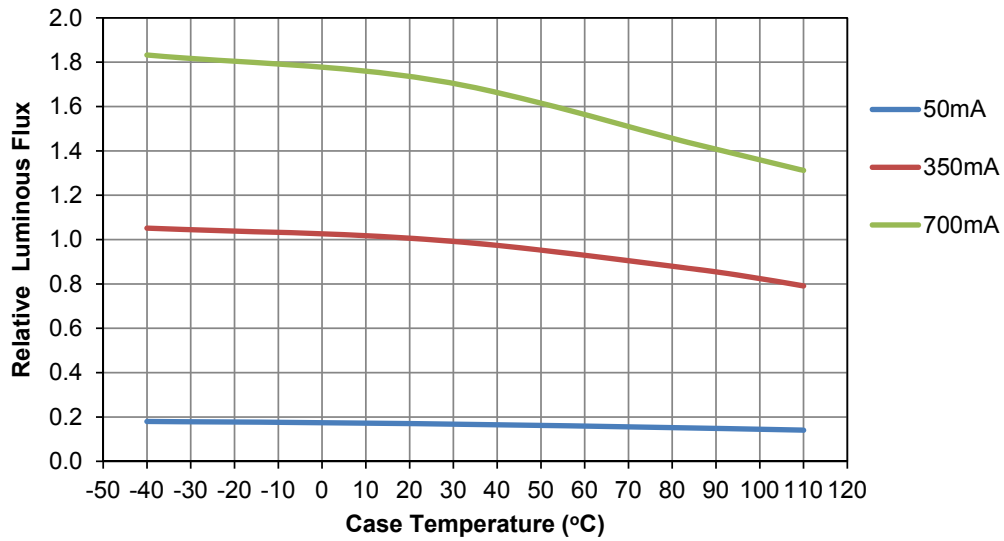

Figure 8. Relative luminous flux vs. case temperature LUXEON F PC Amber MP^[1] (350mA normalization).

Forward Current (mA)	Relative Luminous Flux vs. Thermal Pad Temperature for LUXEON F PC Amber
50	$y = -1.18E-6x^2 - 1.80E-4x + 1.74E-1$
350	$y = -1.10E-5x^2 - 9.70E-4x + 1.03E0$
700	$y = -1.94E-5x^2 - 2.20E-3x + 1.78E0$

Notes for Figure 8:

1. MP is defined as 20ms monopulse, case temperature is defined in Figure 1.

Light Output Characteristics. Case Temperature for LUXEON F Cool White

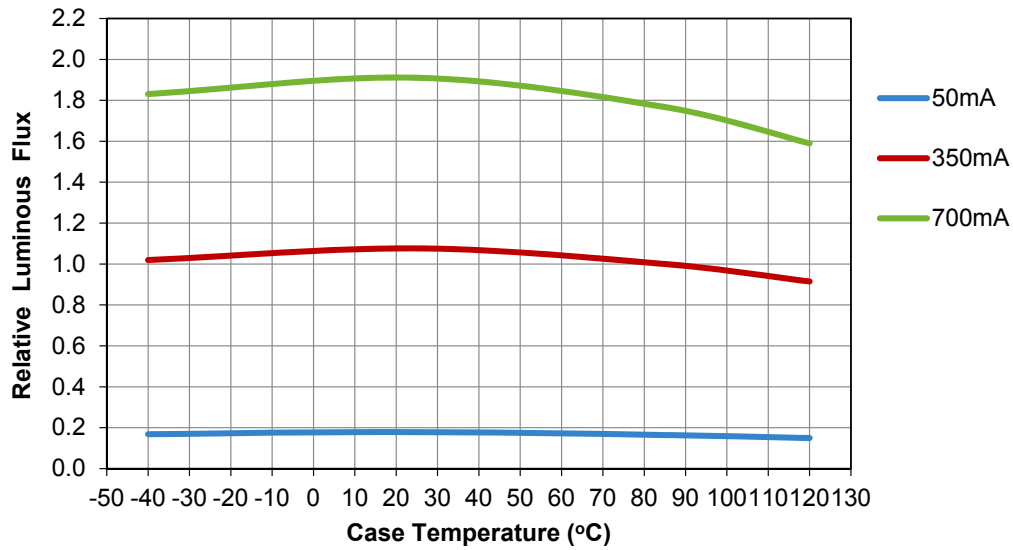

Figure 9. Relative luminous flux vs. case temperature LUXEON F Cool White DC.

Forward Current (mA)	Relative Luminous Flux vs. Thermal Pad Temperature for LUXEON F Cool White
50	$y = -2.87E-6x^2 + 1.06E-4x + 1.77E-1$
350	$y = -1.57E-5x^2 + 5.80E-4x + 1.07E0$
700	$y = -2.87E-5x^2 + 7.83E-4x + 1.91E0$

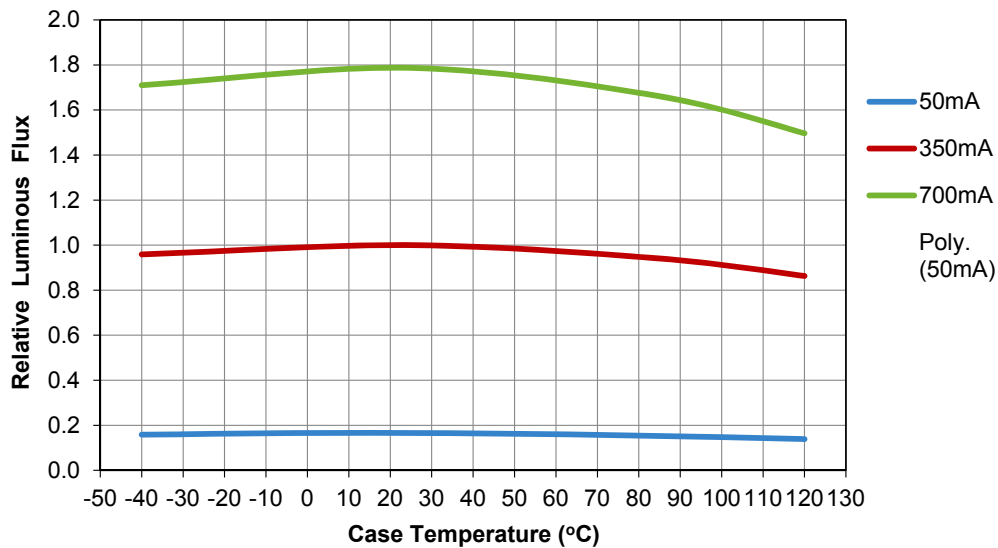

Figure 10. Relative luminous flux vs. case temperature LUXEON F Cool White MP⁽¹⁾.

Forward Current (mA)	Relative Luminous Flux vs. Thermal Pad Temperature for LUXEON F Cool White
50	$y = -2.53E-6x^2 + 7.43E-5x + 1.66E-1$
350	$y = -1.30E-5x^2 + 4.37E-4x + 9.97E-1$
700	$y = -2.66E-5x^2 + 7.95E-4x + 1.78E0$

Notes for Figure 10:

1. MP is defined as 20ms monopulse, case temperature is defined in Figure 1.

Light Output Characteristics. Case Temperature for LUXEON F ES Cool White

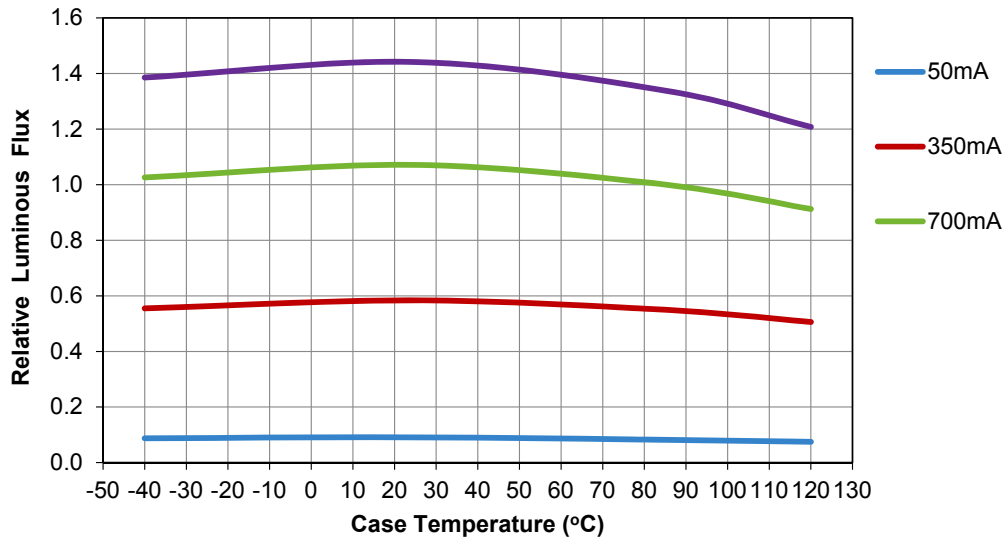

Figure 11. Relative luminous flux vs. case temperature LUXEON F ES Cool White DC.

Forward Current (mA)	Relative Luminous Flux vs. Thermal Pad Temperature for LUXEON F ES Cool White
50	$y = -1.34E-6x^2 + 2.38E-5x + 9.07E-2$
350	$y = -7.81E-6x^2 + 3.16E-4x + 5.80E-1$
700	$y = -1.47E-5x^2 + 4.58E-4x + 1.07E0$
1000	$y = -2.08E-5x^2 + 5.57E-4x + 1.44E0$

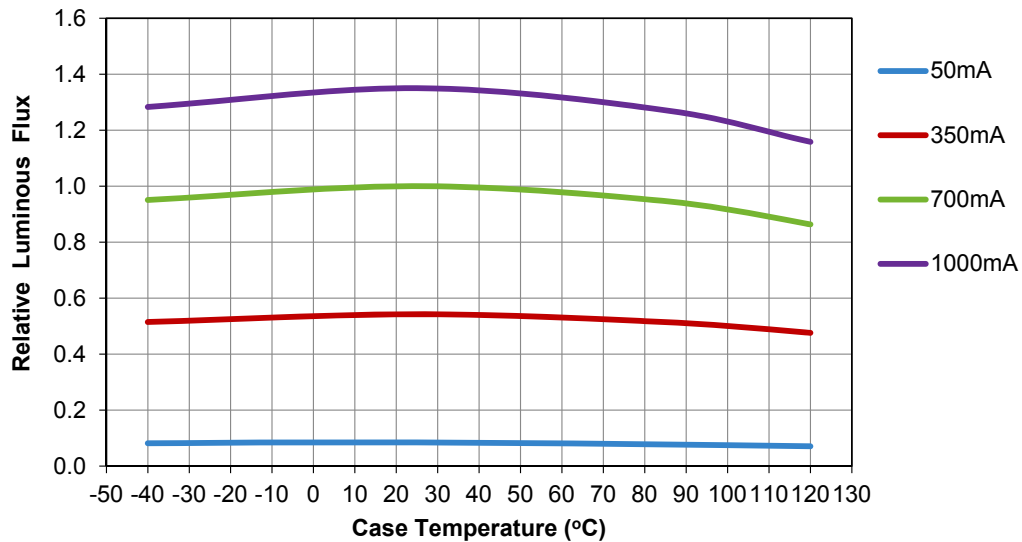

Figure 12. Relative luminous flux vs. case temperature LUXEON F ES Cool White MP⁽¹⁾.

Forward Current (mA)	Relative Luminous Flux vs. Thermal Pad Temperature for LUXEON F ES Cool White
50	$y = -1.18E-6x^2 + 2.41E-5x + 8.42E-2$
350	$y = -6.99E-6x^2 + 3.15E-4x + 5.38E-1$
700	$y = -1.40E-5x^2 + 5.81E-4x + 9.96E-1$
1000	$y = -1.92E-5x^2 + 7.61E-4x + 1.34E0$

Notes for Figure 12:

1. MP is defined as 20ms monopulse, case temperature is defined in Figure 1.

Light Output Characteristics. Case Temperature for LUXEON F Plus PC Amber

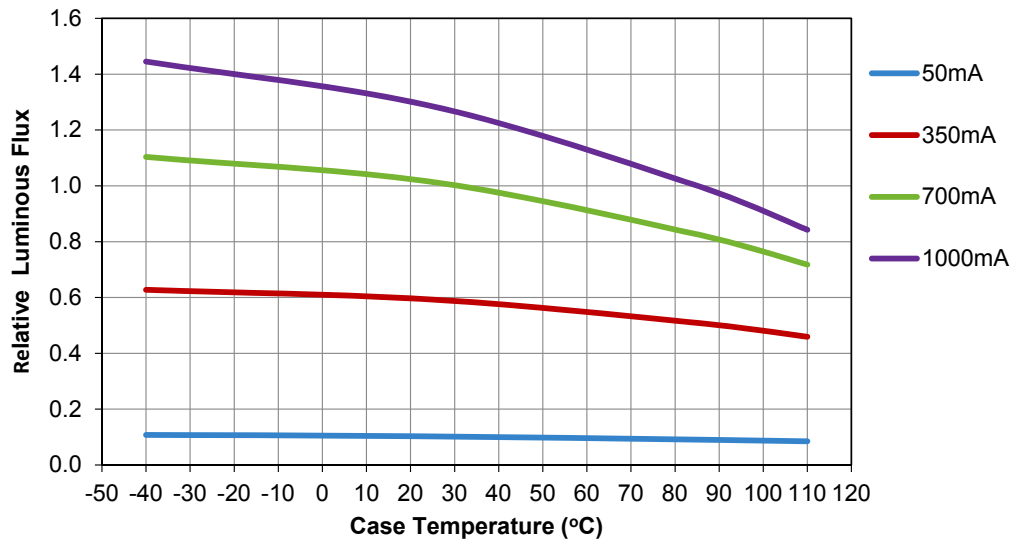

Figure 13. Relative luminous flux vs. case temperature LUXEON F Plus PC Amber DC (1000mA normalization).

Forward Current (mA)	Relative Luminous Flux vs. Thermal Pad Temperature for LUXEON F Plus PC Amber
50	$y = -8.24E-7x^2 - 9.69E-5x + 1.05E-1$
350	$y = -6.89E-6x^2 - 6.38E-4x + 6.13E-1$
700	$y = -1.40E-5x^2 - 1.59E-3x + 1.06E0$
1000	$y = -1.82E-5x^2 - 2.74E-3x + 1.36E0$

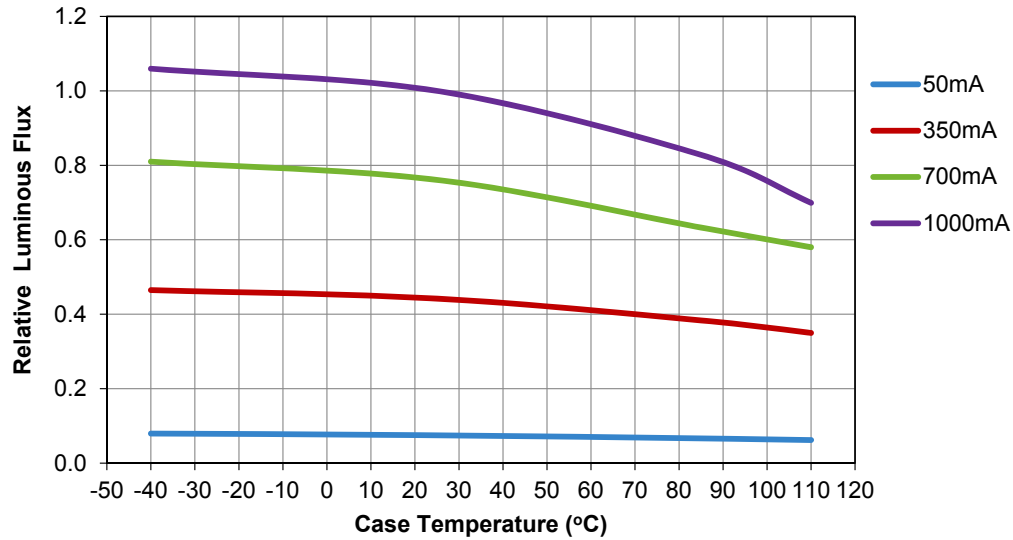

Figure 14. Relative luminous flux vs. case temperature LUXEON F Plus PC Amber MP⁽¹⁾ (1000mA normalization).

Forward Current (mA)	Relative Luminous Flux vs. Thermal Pad Temperature for LUXEON F Plus PC Amber
50	$y = -5.22E-7x^2 - 7.94E-5x + 7.71E-2$
350	$y = -4.87E-6x^2 - 4.29E-4x + 4.56E-1$
700	$y = -8.57E-6x^2 - 9.75E-4x + 7.86E-1$
1000	$y = -1.81E-5x^2 - 1.10E-3x + 1.04E0$

Notes for Figure 14:

1. MP is defined as 20ms monopulse, case temperature is defined in Figure 1.

Light Output Characteristics. Case Temperature for LUXEON F Plus Cool White

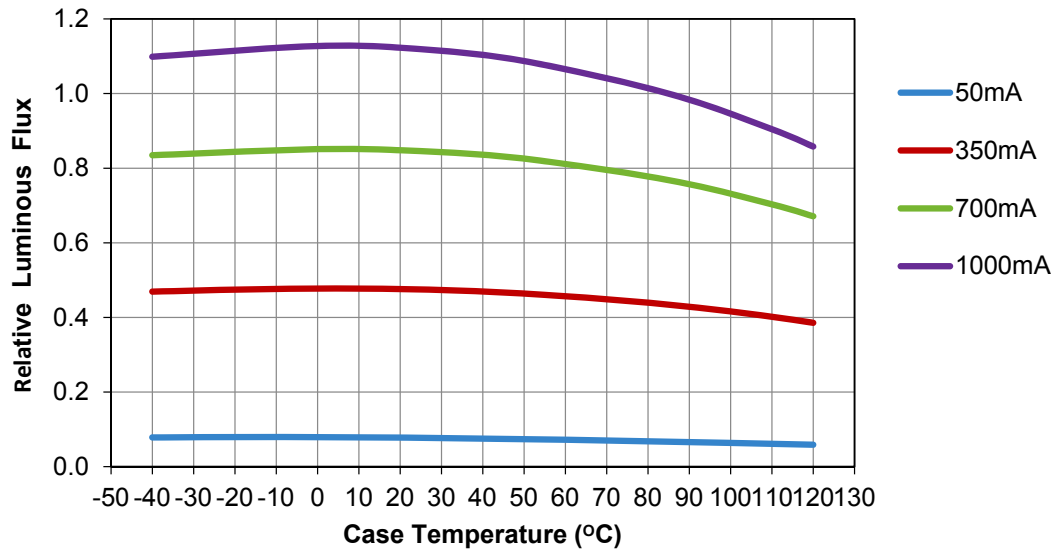

Figure 15. Relative luminous flux vs. case temperature LUXEON F Plus Cool White DC.

Forward Current (mA)	Relative Luminous Flux vs. Thermal Pad Temperature for LUXEON F Plus Cool White
50	$y = -1.06E-6x^2 - 4.18E-5x + 7.88E-2$
350	$y = -6.49E-6x^2 + 8.35E-6x + 4.79E-1$
700	$y = -1.28E-5x^2 + 3.03E-5x + 8.54E-1$
1000	$y = -1.93E-5x^2 + 6.79E-5x + 1.13E0$

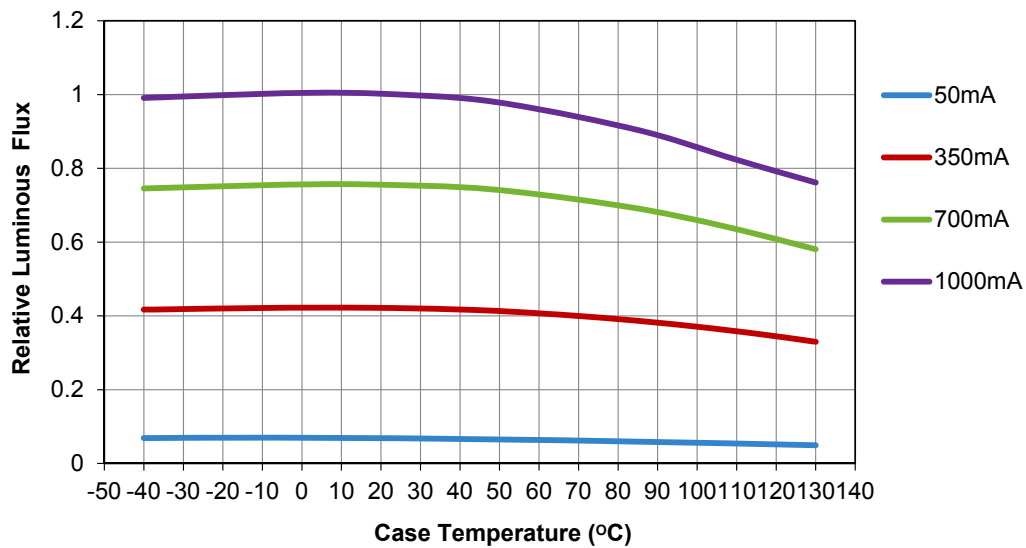

Figure 16. Relative luminous flux vs. case temperature LUXEON F Plus Cool White MP⁽¹⁾.

Forward Current (mA)	Relative Luminous Flux vs. Thermal Pad Temperature for LUXEON F Plus Cool White
50	$y = -9.42E-7x^2 - 3.36E-5x + 6.93E-2$
350	$y = -5.66E-6x^2 + 1.25E-5x + 4.25E-1$
700	$y = -1.11E-5x^2 + 5.85E-5x + 7.62E-1$
1000	$y = -1.46E-5x^2 - 3.51E-5x + 1.01E0$

Notes for Figure 16:

1. MP is defined as 20ms monopulse, case temperature is defined in Figure 1.

Light Output Characteristics. Case Temperature for LUXEON F Premium Cool White

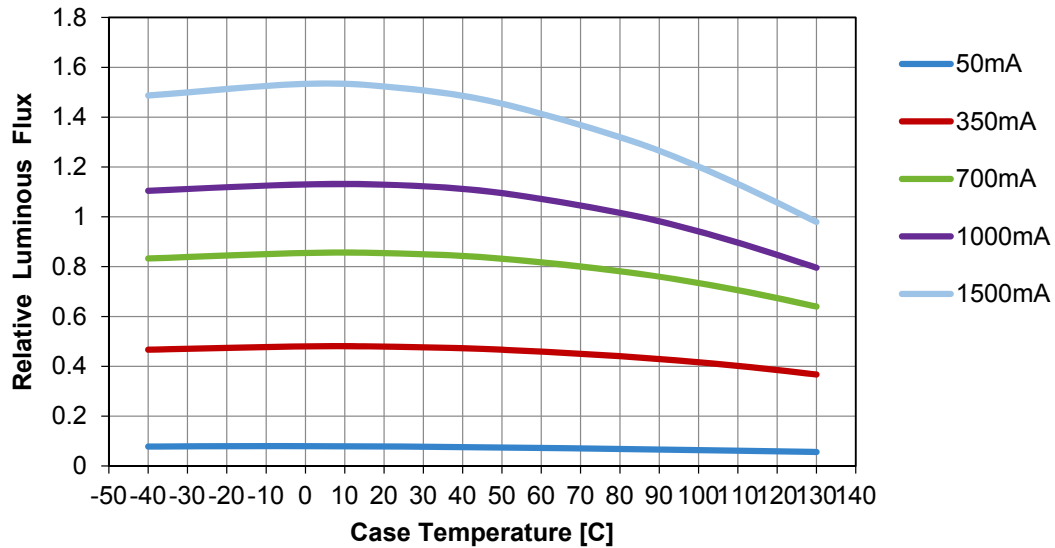

Figure 17. Relative luminous flux vs. case temperature LUXEON F Premium Cool White DC.

Forward Current (mA)	Relative Luminous Flux vs. Thermal Pad Temperature for LUXEON F Premium Cool White
50	$y = -1.13E-6x^2 - 3.36E-5x + 7.89E-2$
350	$y = -7.27E-6x^2 + 7.52E-5x + 4.81E-1$
700	$y = -1.39E-5x^2 + 1.34E-4x + 8.58E-1$
1000	$y = -2.09E-5x^2 + 1.04E-4x + 1.14E0$
1500	$y = -3.26E-5x^2 - 6.41E-5x + 1.54E0$

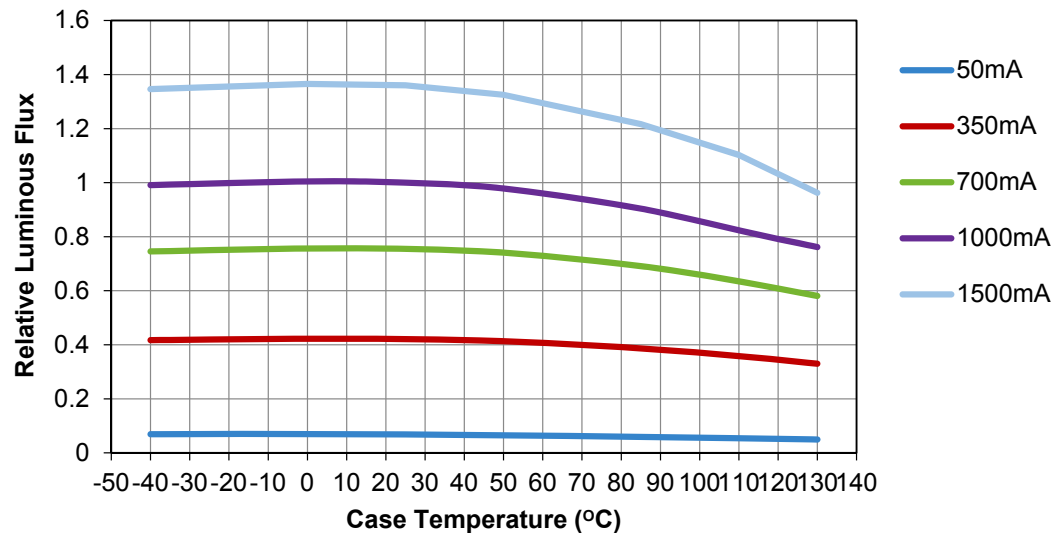

Figure 18. Relative luminous flux vs. case temperature LUXEON F Premium Cool White MP⁽¹⁾.

Forward Current (mA)	Relative Luminous Flux vs. Thermal Pad Temperature for LUXEON F Premium Cool White
50	$y = -9.42E-7x^2 - 3.36E-5x + 6.93E-2$
350	$y = -5.66E-6x^2 + 1.25E-5x + 4.25E-1$
700	$y = -1.11E-5x^2 + 5.85E-5x + 7.62E-1$
1000	$y = -1.46E-5x^2 - 3.51E-5x + 1.01E0$
1500	$y = -2.44E-5x^2 + 6.07E-5x + 1.38E0$

Notes for Figure 18:

1. MP is defined as 20ms monopulse, case temperature is defined in Figure 1.

Typical Light Output Characteristics LUXEON F PC Amber & Plus PC Amber

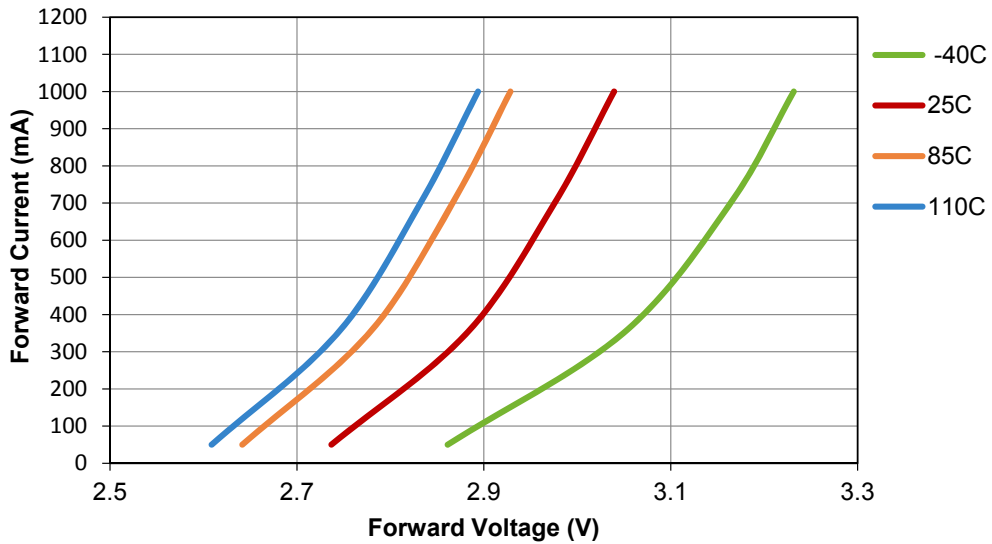

Figure 19. LUXEON F Plus PC Amber / LUXEON F PC Amber forward current vs. forward voltage DC.

Case Temperature	Forward Current vs. Forward Voltage
-40C	$y = 5441.6x^2 - 30608x + 43080$
25C	$y = 6739x^2 - 35782x + 47504$
85C	$y = 7177.3x^2 - 36659x + 46803$
110C	$y = 7268.1x^2 - 36652x + 46201$

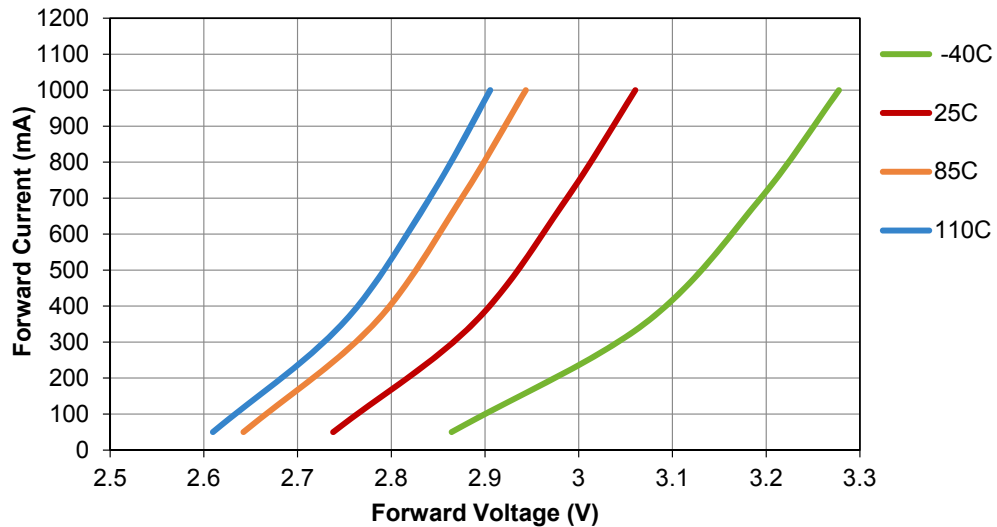

Figure 20. LUXEON F Plus PC Amber / LUXEON F PC Amber forward current vs. forward voltage MP^[1].

Case Temperature	Forward Current vs. Forward Voltage
-40C	$y = 4005.5x^2 - 22301x + 31064$
25C	$y = 5210.7x^2 - 27253x + 35605$
85C	$y = 5956.4x^2 - 30100x + 37996$
110C	$y = 6456.4x^2 - 32391x + 40609$

Notes for Figures 19 & 20:

1. MP is defined as 20ms monopulse, case temperature is defined in Figure 1.
2. Driving these high power devices at currents less than the test current specified in Table 1 for each LUXEON F type may produce unpredictable results and may result in variation in performance. Pulse Width Modulation (PWM) is recommended for dimming effects.

Typical Light Output Characteristics LUXEON F Cool White

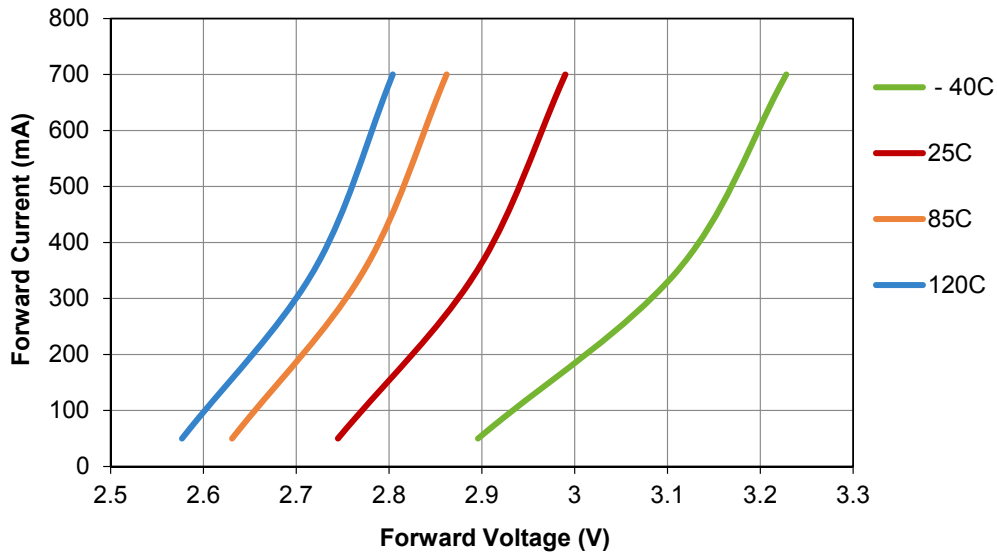

Figure 21. LUXEON F Cool White forward current vs. forward voltage DC.

Case Temperature	Forward Current vs. Forward Voltage
-40C	$y = 4807.5x^2 - 27484x + 39322$
25C	$y = 6874.3x^2 - 36771x + 49189$
85C	$y = 7878.4x^2 - 40462x + 51970$
120C	$y = 8832.5x^2 - 44664x + 56494$

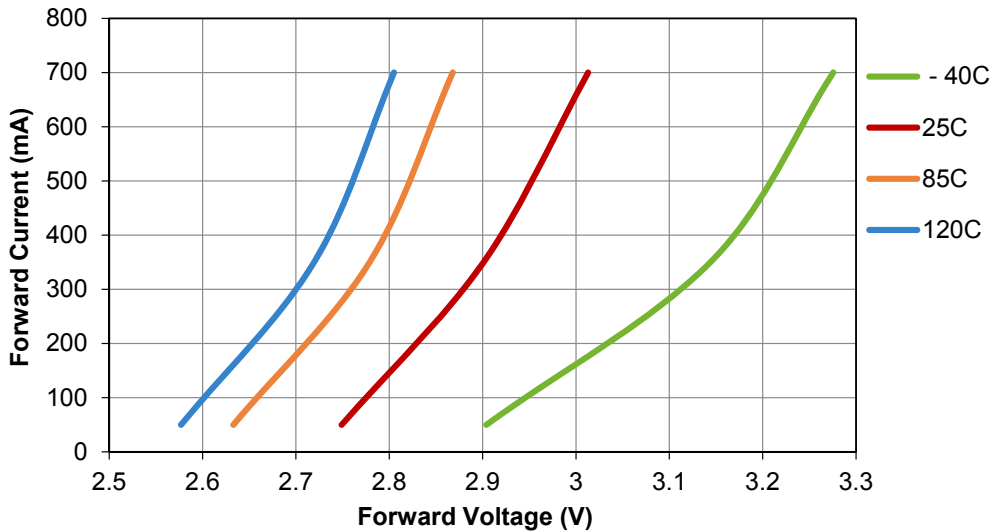

Figure 22. LUXEON F Cool White forward current vs. forward voltage MP⁽¹⁾.

Case Temperature	Forward Current vs. Forward Voltage
-40C	$y = 3799.7x^2 - 21731x + 31112$
25C	$y = 4361x^2 - 22666x + 29403$
85C	$y = 7990.6x^2 - 41190x + 53108$
120C	$y = 8720.6x^2 - 44084x + 55740$

Notes for Figures 21 & 22:

1. MP is defined as 20ms monopulse, case temperature is defined in Figure 1.
2. Driving these high power devices at currents less than the test current specified in Table 1 for each LUXEON F type may produce unpredictable results and may result in variation in performance. Pulse Width Modulation (PWM) is recommended for dimming effects.

Typical Light Output Characteristics LUXEON F ES Cool White

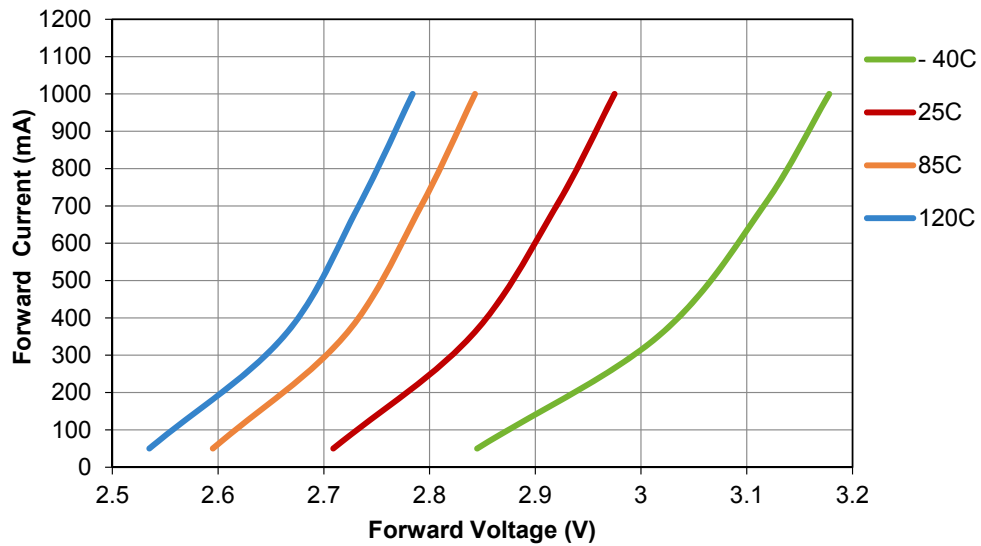

Figure 23. LUXEON F ES Cool White forward current vs. forward voltage DC.

Case Temperature	Forward Current vs. Forward Voltage
-40C	$y = 6862.3x^2 - 38489x + 54009$
25C	$y = 9221.2x^2 - 48836x + 64676$
85C	$y = 11199x^2 - 57054x + 72692$
120C	$y = 11637x^2 - 58059x + 72449$

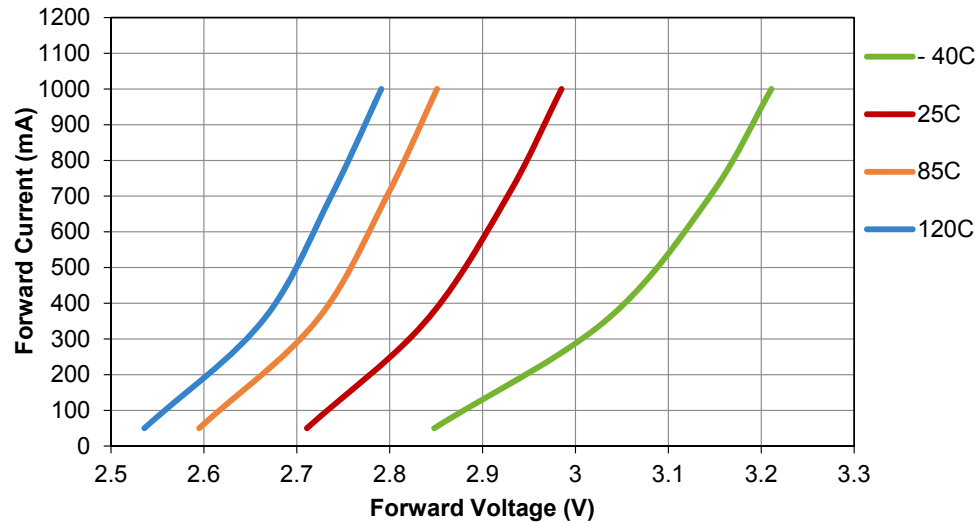

Figure 24. LUXEON F ES Cool White forward current vs. forward voltage MP^[1].

Case Temperature	Forward Current vs. Forward Voltage
-40C	$y = 5650.8x^2 - 31641x + 44332$
25C	$y = 7736.2x^2 - 40601x + 53263$
85C	$y = 10010x^2 - 50789x + 64436$
120C	$y = 10340x^2 - 51331x + 63727$

Notes for Figures 23 & 24:

1. MP is defined as 20ms monopulse, case temperature is defined in Figure 1.
2. Driving these high power devices at currents less than the test current specified in Table 1 for each LUXEON F type may produce unpredictable results and may result in variation in performance. Pulse Width Modulation (PWM) is recommended for dimming effects.

Typical Light Output Characteristics LUXEON F Plus Cool White

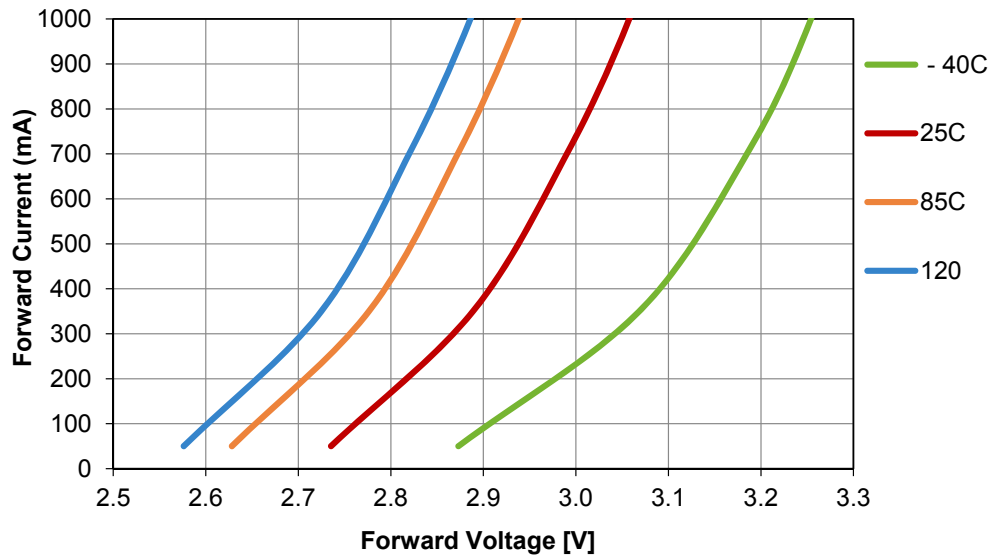

Figure 25. LUXEON F Plus Cool White forward current vs. forward voltage DC.

Case Temperature	Forward Current vs. Forward Voltage
-40C	$y = 6181.9x^2 - 35346x + 50579$
25C	$y = 6125.4x^2 - 32525x + 43188$
85C	$y = 6095x^2 - 30868x + 39076$
120C	$y = 6024.7x^2 - 29850x + 36962$

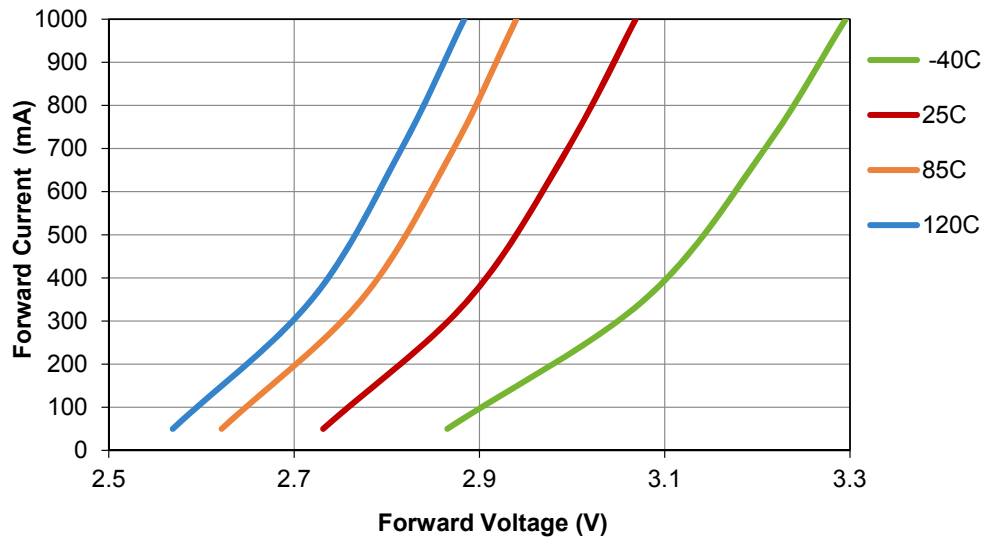

Figure 26. LUXEON F Plus Cool White forward current vs. forward voltage MP^[1].

Case Temperature	Forward Current vs. Forward Voltage
-40C	$y = 3673.7x^2 - 20421x + 28402$
25C	$y = 4974.3x^2 - 26032x + 34042$
85C	$y = 5940.6x^2 - 30050x + 37999$
120C	$y = 6094.1x^2 - 30201x + 37417$

Notes for Figures 25 & 26:

1. MP is defined as 20ms monopulse, case temperature is defined in Figure 1.
2. Driving these high power devices at currents less than the test current specified in Table 1 for each LUXEON F type may produce unpredictable results and may result in variation in performance. Pulse Width Modulation (PWM) is recommended for dimming effects.

Typical Light Output Characteristics LUXEON F Premium Cool White

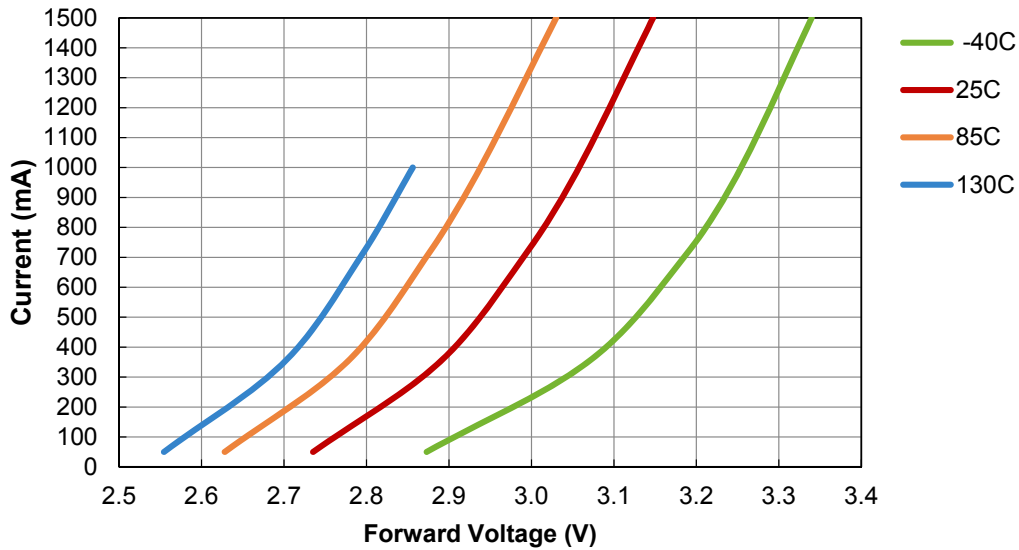

Figure 27. LUXEON F Plus Cool White forward current vs. forward voltage DC.

Case Temperature	Forward Current vs. Forward Voltage
-40C	$y = 6181.9x^2 - 35346x + 50579$
25C	$y = 6125.4x^2 - 32525x + 43188$
85C	$y = 6095x^2 - 30868x + 39076$
130C	$y = 6024.7x^2 - 29850x + 36962$

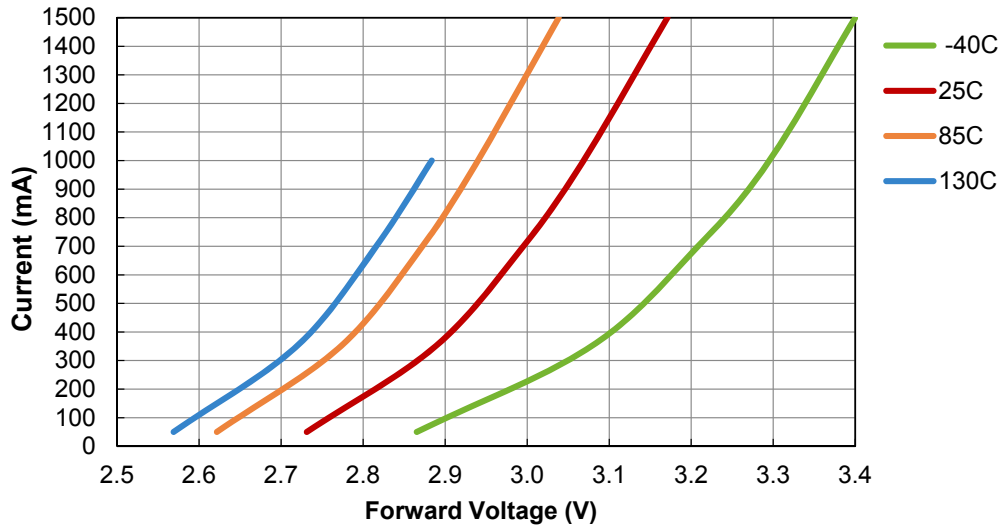

Figure 28. LUXEON F Premium Cool White forward current vs. forward voltage MP^[1].

Case Temperature	Forward Current vs. Forward Voltage
-40C	$y = 4201.5x^2 - 23637x + 33287$
25C	$y = 4815.5x^2 - 25118x + 32730$
85C	$y = 5395.9x^2 - 27044x + 33862$
130C	$y = 5693.8x^2 - 27875x + 34098$

Notes for Figures 27 & 28:

1. MP is defined as 20ms monopulse, case temperature is defined in Figure 1.
2. Driving these high power devices at currents less than the test current specified in Table 1 for each LUXEON F type may produce unpredictable results and may result in variation in performance. Pulse Width Modulation (PWM) is recommended for dimming effects.

Typical Relative Luminous Flux LUXEON F PC Amber

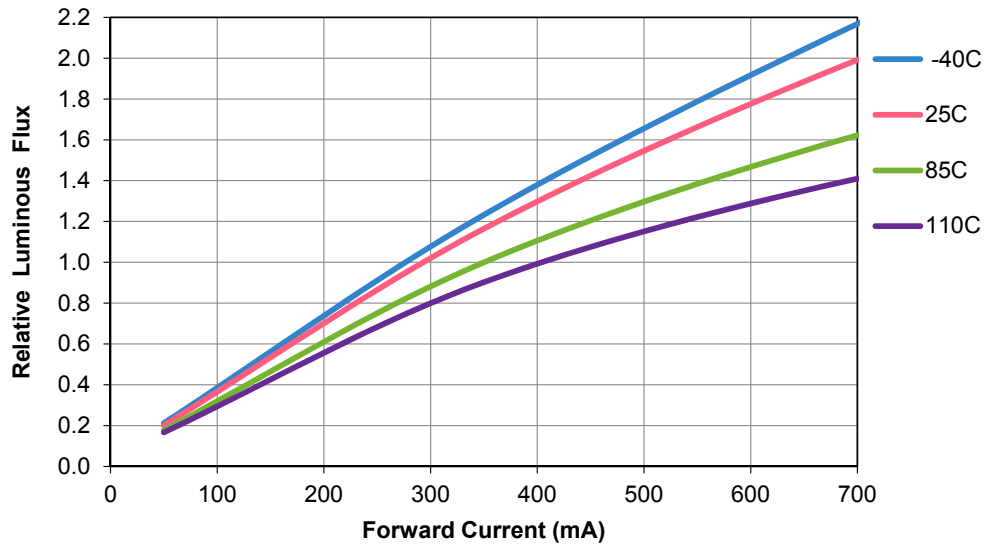

Figure 29. LUXEON F PC Amber relative luminous flux vs. forward current DC.

Case Temperature	Relative Luminous Flus vs. Forward Current
-40C	$y = 6181.9x^2 - 35346x + 50579$
25C	$y = 6125.4x^2 - 32525x + 43188$
85C	$y = 6095x^2 - 30868x + 39076$
130C	$y = 6024.7x^2 - 29850x + 36962$

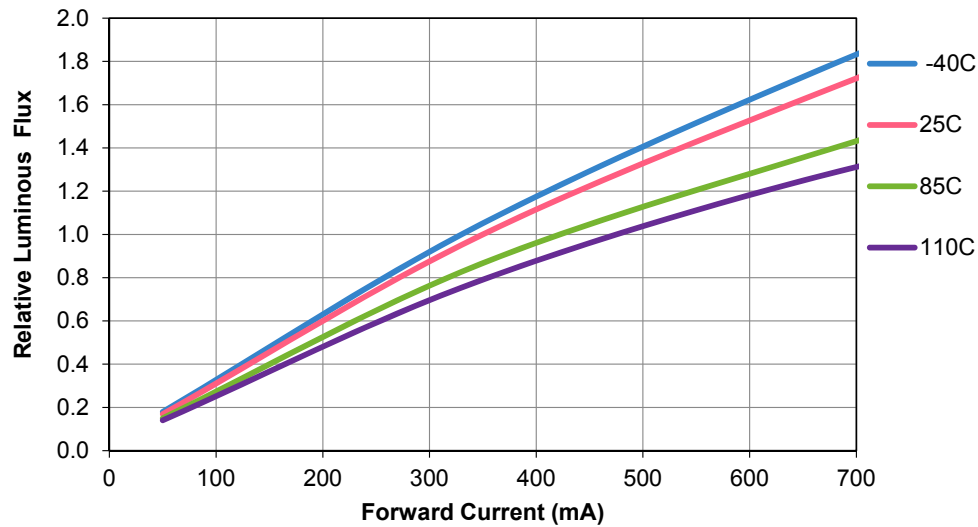

Figure 30. LUXEON F PC Amber relative luminous flux vs. forward current MP^[1].

Case Temperature	Relative Luminous Flus vs. Forward Current
-40C	$y = -7.87E-7x^2 + 3.15E-3x + 3.00E-2$
25C	$y = -7.44E-7x^2 + 2.97E-3x + 3.08E-2$
85C	$y = -7.06E-7x^2 + 2.53E-3x + 3.70E-2$
110C	$y = -9.77E-7x^2 + 2.54E-3x + 1.76E-2$

Notes for Figures 29 & 30:

1. MP is defined as 20ms monopulse, case temperature is defined in Figure 1.

Typical Relative Luminous Flux LUXEON F Cool White

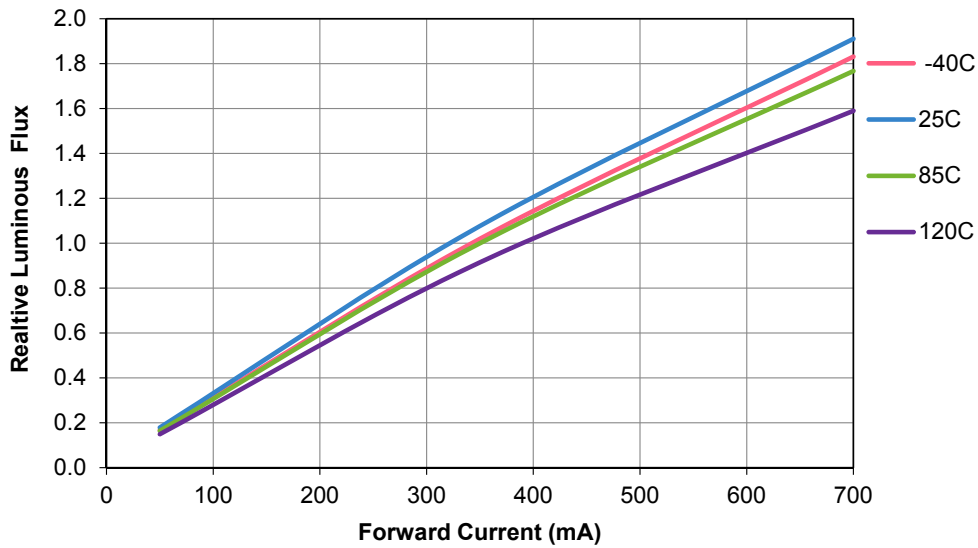

Figure 31. LUXEON F Cool White relative luminous flux vs. forward current DC.

Case Temperature	Relative Luminous Flux vs. Forward Current
-40C	$y = -7.98E-7x^2 + 3.16E-3x + 1.24E-2$
25C	$y = -9.35E-7x^2 + 3.36E-3x + 1.34E-2$
85C	$y = -9.16E-7x^2 + 3.15E-3x + 8.92E-3$
120C	$y = -9.56E-7x^2 + 2.93E-3x + 5.33E-3$

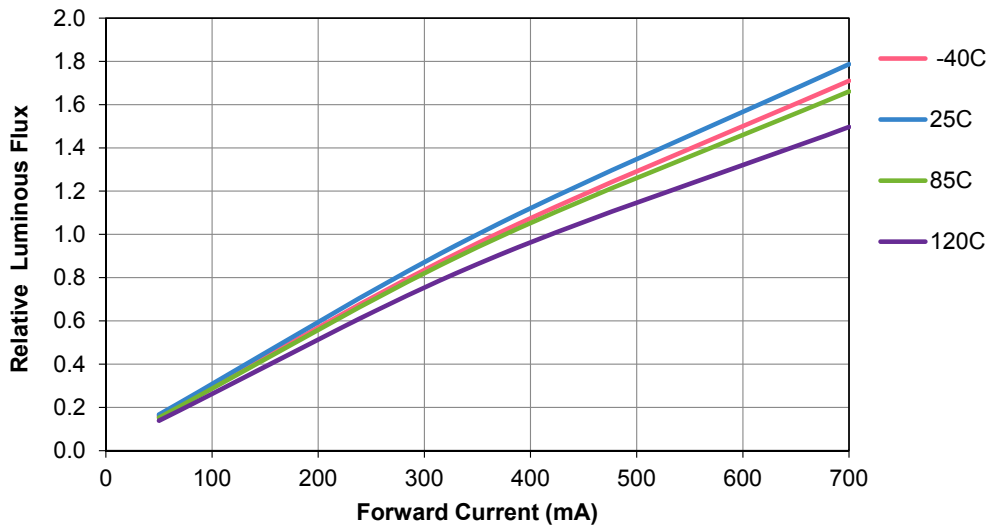

Figure 32. LUXEON F Cool White relative luminous flux vs. forward current MP^[1].

Case Temperature	Relative Luminous Flux vs. Forward Current
-40C	$y = -8.02E-7x^2 + 2.99E-3x + 1.10E-2$
25C	$y = -8.14E-7x^2 + 3.10E-3x + 1.35E-2$
85C	$y = -8.75E-7x^2 + 2.98E-3x + 6.09E-3$
120C	$y = -9.29E-7x^2 + 2.79E-3x + 1.73E-3$

Notes for Figures 31 & 32:

1. MP is defined as 20ms monopulse, case temperature is defined in Figure 1.

Typical Relative Luminous Flux LUXEON F ES Cool White

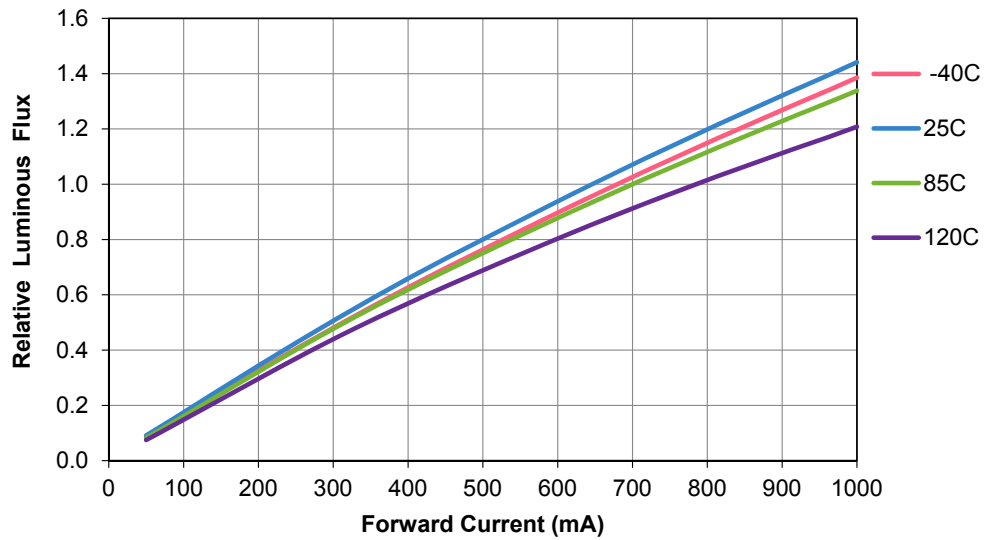

Figure 33. LUXEON F ES Cool White relative luminous flux vs. forward current DC.

Case Temperature	Relative Luminous Flux vs. Forward Current
-40C	$y = -2.77E-7x^2 + 1.66E-3x + 6.42E-3$
25C	$y = -3.14E-7x^2 + 1.75E-3x + 6.28E-3$
85C	$y = -3.32E-7x^2 + 1.67E-3x + 1.48E-3$
120C	$y = -3.48E-7x^2 + 1.55E-3x - 2.89E-4$

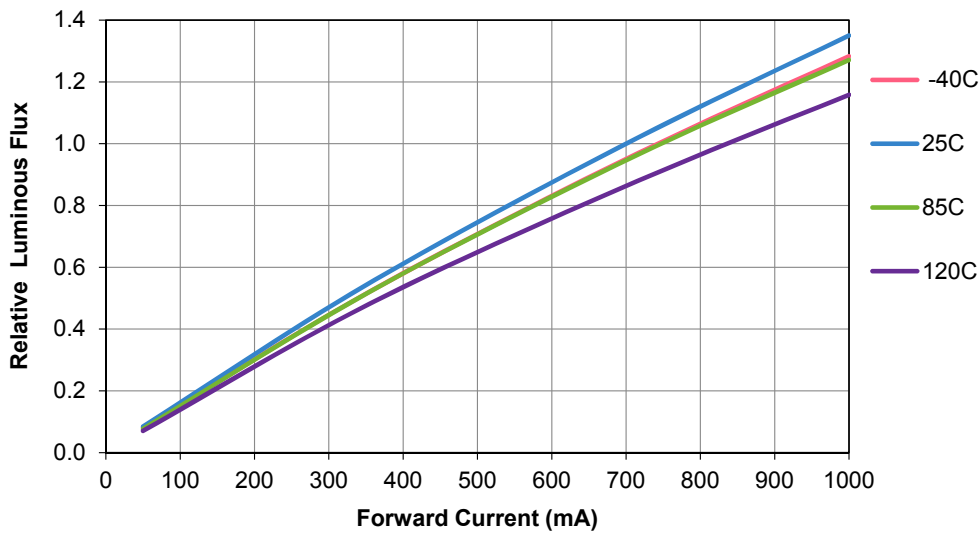

Figure 34. LUXEON F ES Cool White relative luminous flux vs. forward current MP^[1].

Case Temperature	Relative Luminous Flux vs. Forward Current
-40C	$y = -2.59E-7x^2 + 1.53E-3x + 6.24E-3$
25C	$y = -2.76E-7x^2 + 1.62E-3x + 5.72E-3$
85C	$y = -2.88E-7x^2 + 1.56E-3x + 1.16E-3$
120C	$y = -2.83E-7x^2 + 1.44E-3x + 1.49E-3$

Notes for Figures 33 & 34:

1. MP is defined as 20ms monopulse, case temperature is defined in Figure 1.

Typical Relative Luminous Flux LUXEON F Plus PC Amber

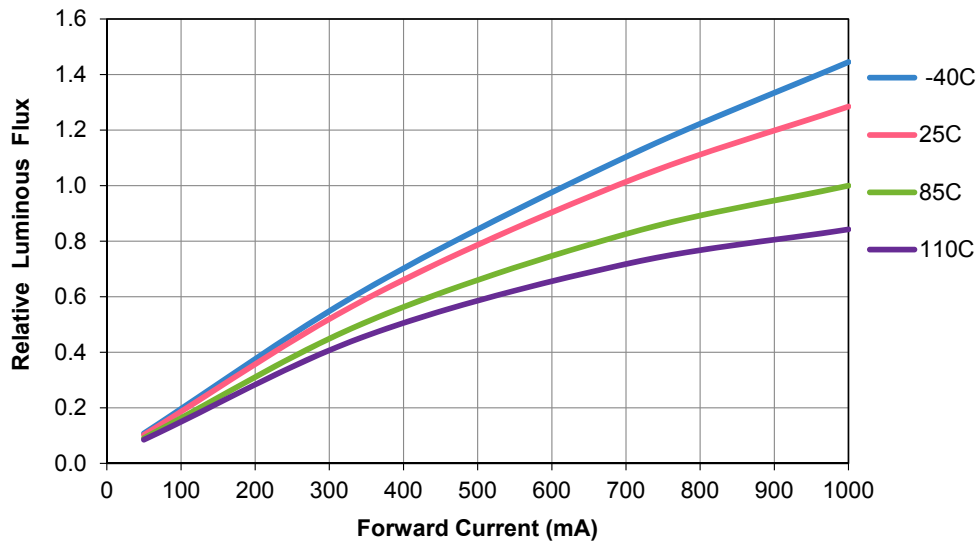

Figure 35. LUXEON F Plus PC Amber relative luminous flux vs. forward current DC.

Case Temperature	Relative Luminous Flux vs. Forward Current
-40C	$y = -4.57E-7x^2 + 1.88E-3x + 1.76E-2$
25C	$y = -5.62E-7x^2 + 1.83E-3x + 1.48E-2$
85C	$y = -6.26E-7x^2 + 1.61E-3x + 1.49E-2$
110C	$y = -6.40E-7x^2 + 1.46E-3x + 1.67E-2$

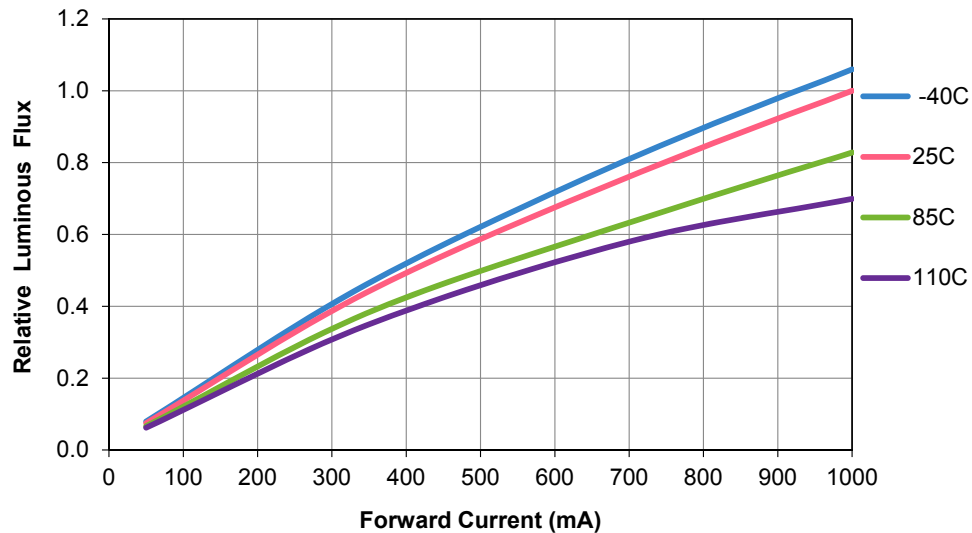

Figure 36. LUXEON F Plus PC Amber relative luminous flux vs. forward current MP^[1].

Case Temperature	Relative Luminous Flux vs. Forward Current
-40C	$y = -3.48E-7x^2 + 1.39E-3x + 1.33E-2$
25C	$y = -3.29E-7x^2 + 1.31E-3x + 1.36E-2$
85C	$y = -3.12E-7x^2 + 1.12E-3x + 1.64E-2$
110C	$y = -4.32E-7x^2 + 1.12E-3x + 7.77E-3$

Notes for Figures 35 & 36:

1. MP is defined as 20ms monopulse, case temperature is defined in Figure 1.

Typical Relative Luminous Flux LUXEON F Plus Cool White

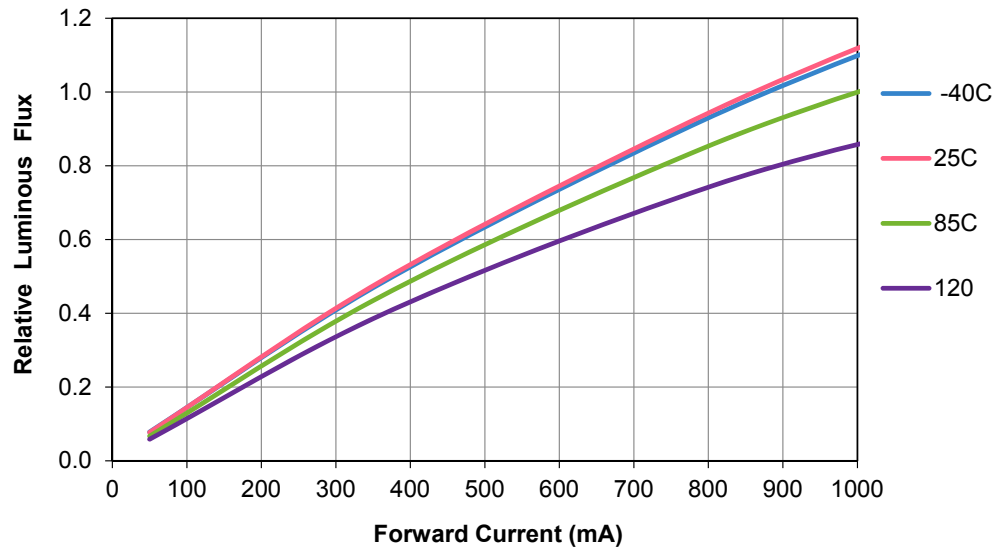

Figure 37. LUXEON F Plus Cool White relative luminous flux vs. forward current DC.

Case Temperature	Relative Luminous Flux vs. Forward Current
-40C	$y = -2.51E-7x^2 + 1.34E-3x + 1.88E-2$
25C	$y = -2.38E-7x^2 + 1.35E-3x + 1.79E-2$
85C	$y = -2.82E-7x^2 + 1.28E-3x + 9.95E-3$
120C	$y = -2.97E-7x^2 + 1.16E-3x + 7.38E-3$

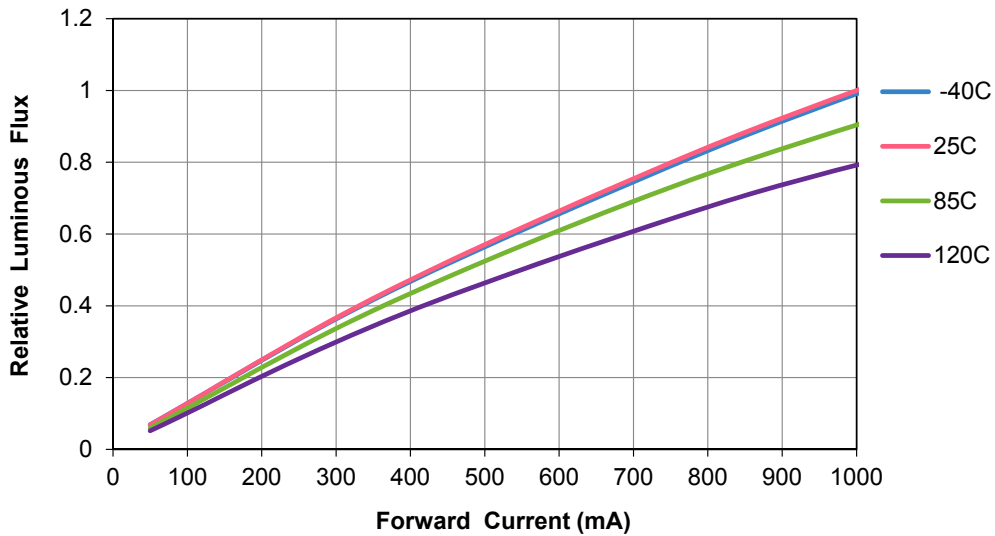

Figure 38. LUXEON F Plus Cool White relative luminous flux vs. forward current MP^[1].

Case Temperature	Relative Luminous Flux vs. Forward Current
-40C	$y = -1.97E-7x^2 + 1.18E-3x + 1.68E-2$
25C	$y = -2.00E-7x^2 + 1.19E-3x + 1.56E-2$
85C	$y = -2.08E-7x^2 + 1.11E-3x + 1.10E-2$
120C	$y = -2.21E-7x^2 + 1.01E-3x + 6.76E-3$

Notes for Figures 37 & 38:

1. MP is defined as 20ms monopulse, case temperature is defined in Figure 1.

Typical Relative Luminous Flux LUXEON F Premium Cool White

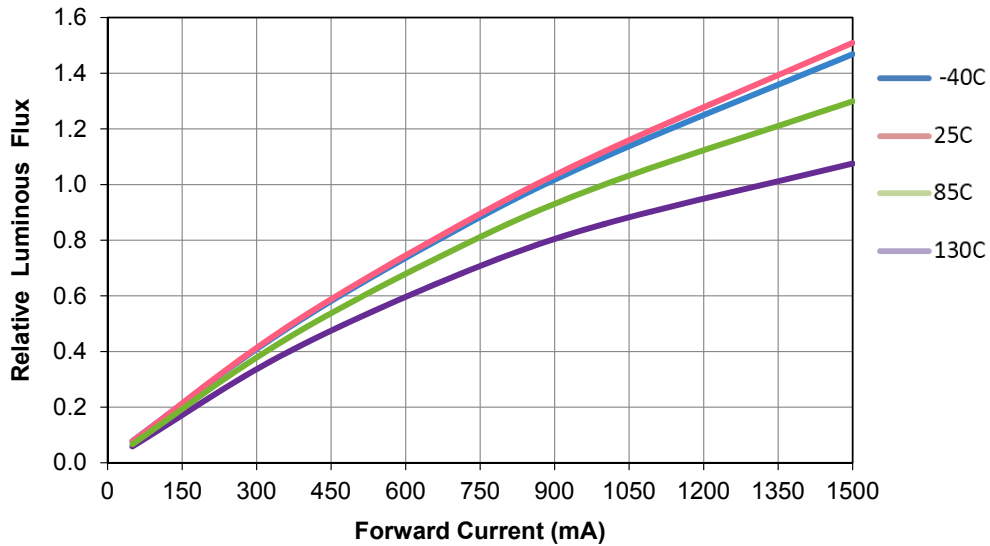

Figure 39. LUXEON F Premium Cool White relative luminous flux vs. forward current DC (1000mA normalization).

Case Temperature	Relative Luminous Flux vs. Forward Current
-40C	$y = -2.51E-7x^2 + 1.34E-3x + 1.88E-2$
25C	$y = -2.38E-7x^2 + 1.35E-3x + 1.79E-2$
85C	$y = -2.82E-7x^2 + 1.28E-3x + 9.95E-3$
130C	$y = -2.97E-7x^2 + 1.16E-3x + 7.38E-3$

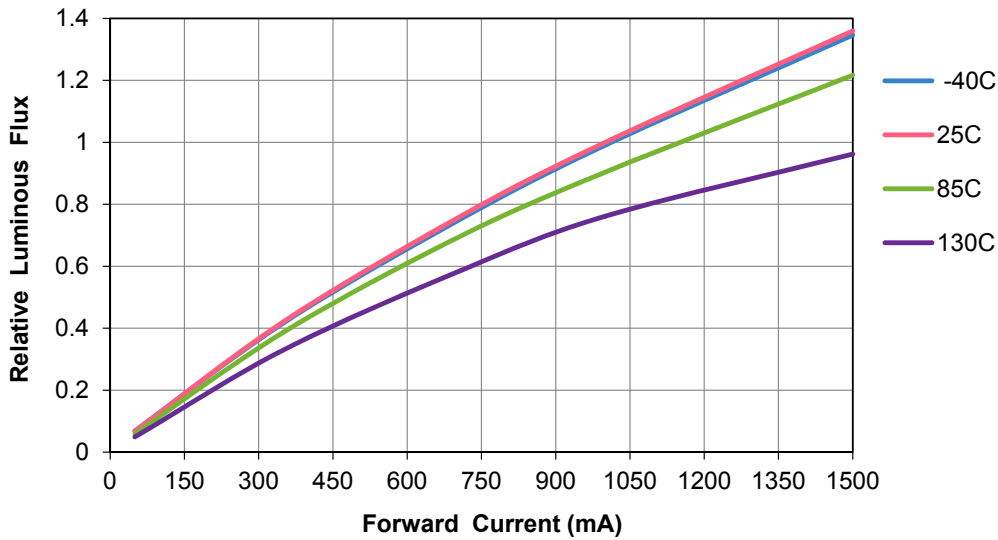

Figure 40. LUXEON F Premium Cool White relative luminous flux vs. forward current MP⁽¹⁾ (1000mA normalization).

Case Temperature	Relative Luminous Flux vs. Forward Current
-40C	$y = -1.97E-7x^2 + 1.18E-3x + 1.68E-2$
25C	$y = -2.00E-7x^2 + 1.19E-3x + 1.56E-2$
85C	$y = -2.08E-7x^2 + 1.11E-3x + 1.10E-2$
130C	$y = -2.40E-7x^2 + 9.99E-4x + 2.90E-3$

Notes for Figures 39 & 40:

1. MP is defined as 20ms monopulse, case temperature is defined in Figure 1.

Typical Color Shift LUXEON F PC Amber

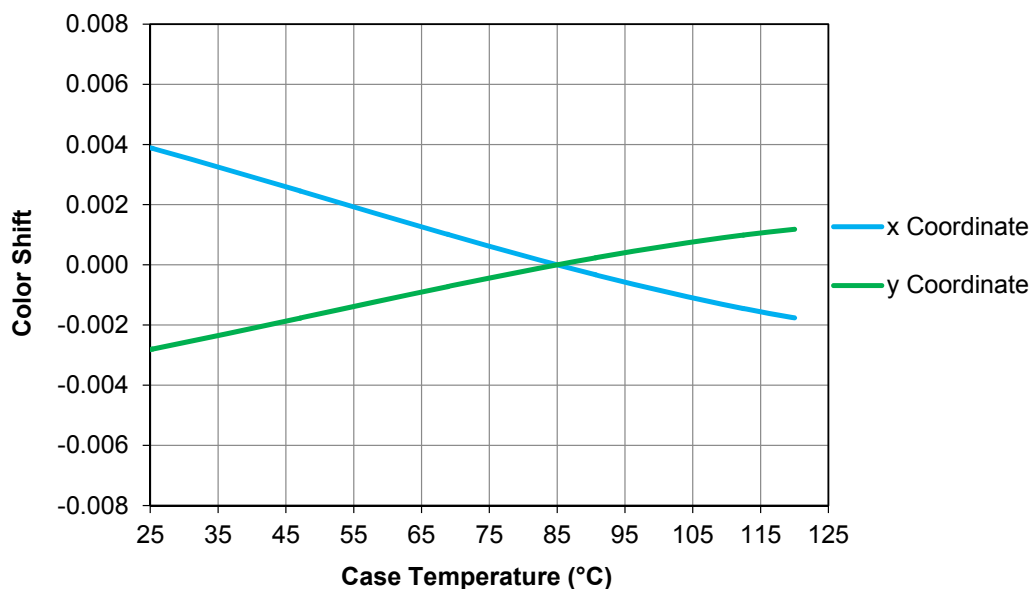

Figure 41. LUXEON F PC Amber color shift range in CIE1931 y coordinate, DC at 350mA.

Typical Color Shift LUXEON F Cool White

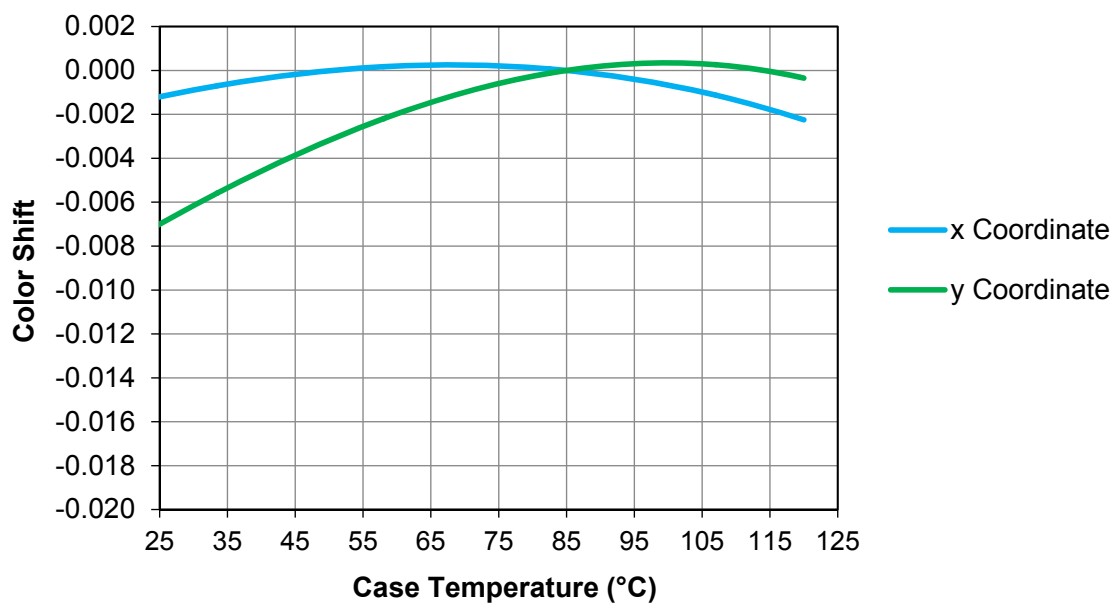

Figure 42. LUXEON F Cool White color shift range in CIE1931 y coordinate, DC at 350mA.

Typical Color Shift LUXEON F ES Cool White

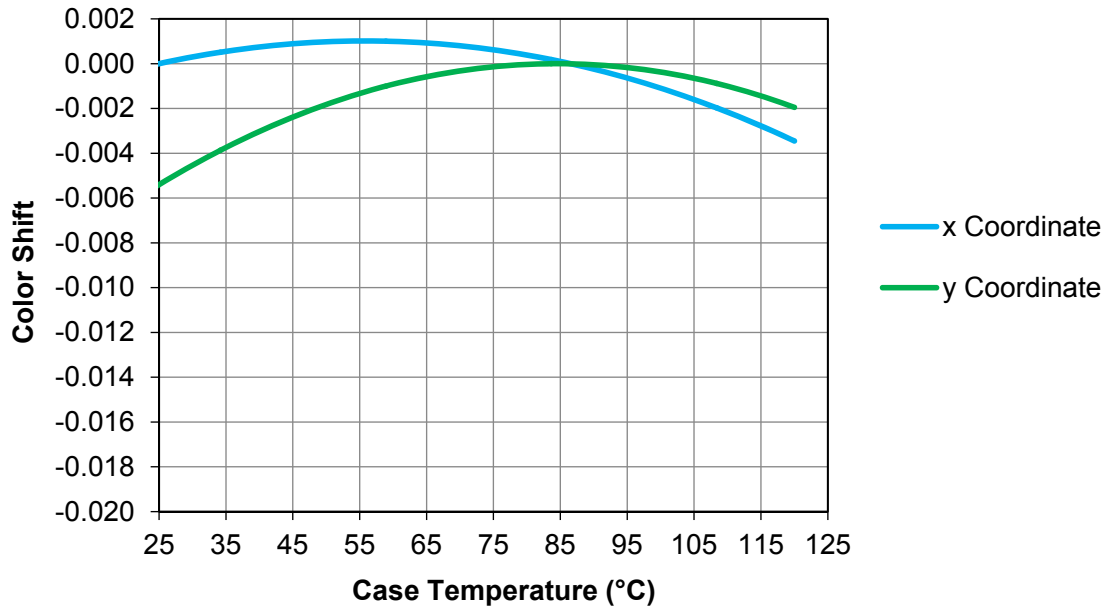

Figure 43. LUXEON F ES Cool White color shift range in CIE1931 y coordinate, DC at 700mA.

Typical Color Shift LUXEON F Plus PC Amber

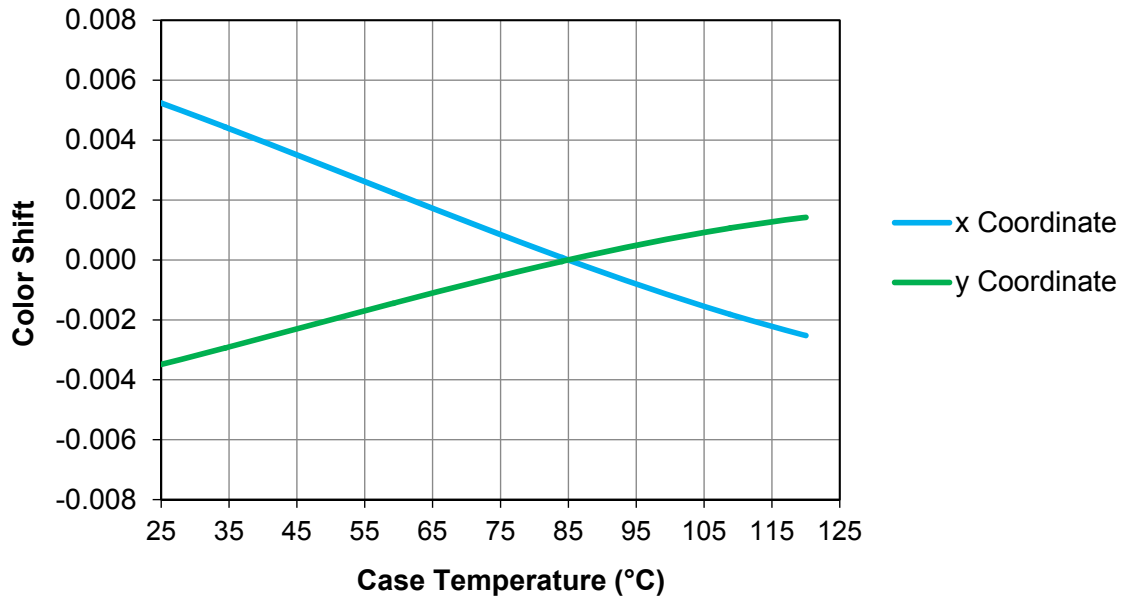

Figure 44. LUXEON F Plus PC Amber color shift range in CIE1931 y coordinate, DC at 1000mA.

Typical Color Shift LUXEON F Plus Cool White

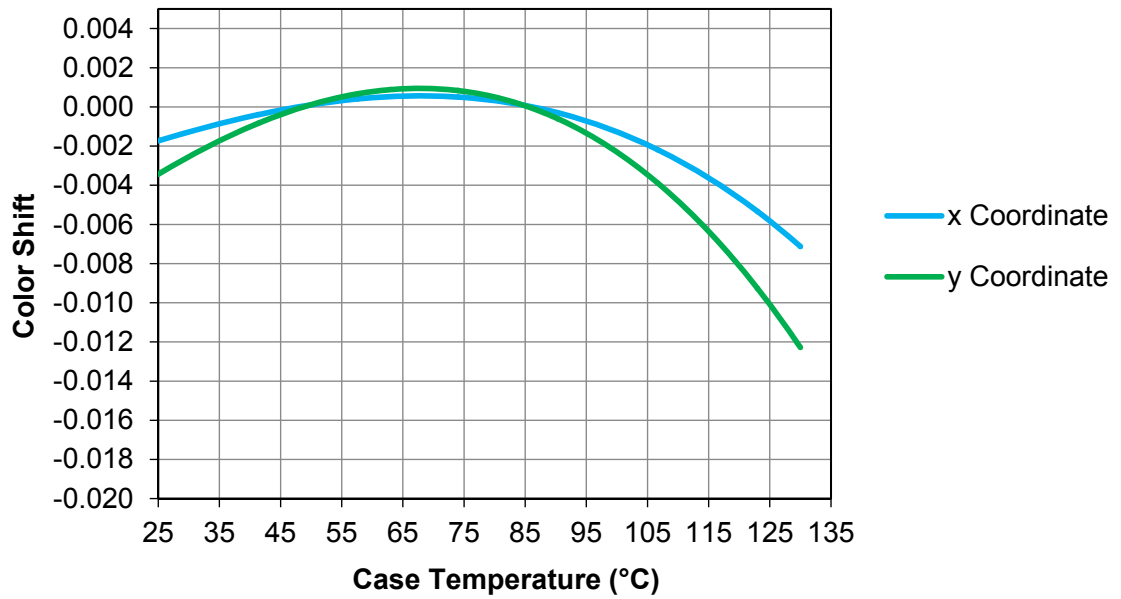

Figure 45. LUXEON F Plus Cool White color shift range in CIE1931 y coordinate, DC at 1000mA.

Typical Color Shift LUXEON F Premium Cool White

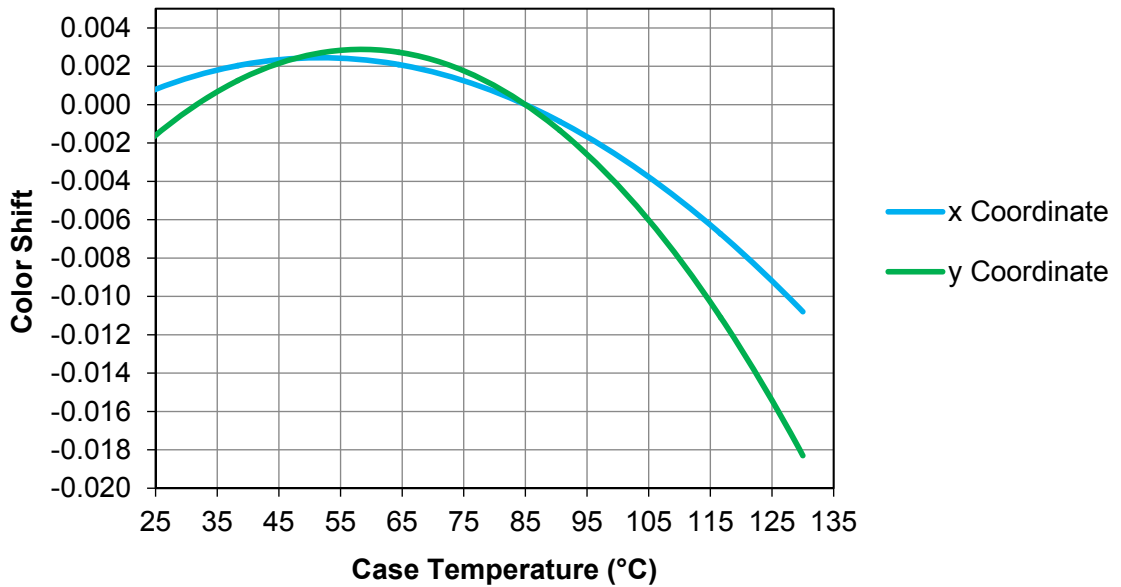

Figure 46. LUXEON F Premium Cool White color shift range in CIE1931 y coordinate, DC at 1000mA.

Current Derating Curve LUXEON F PC Amber & Plus PC Amber

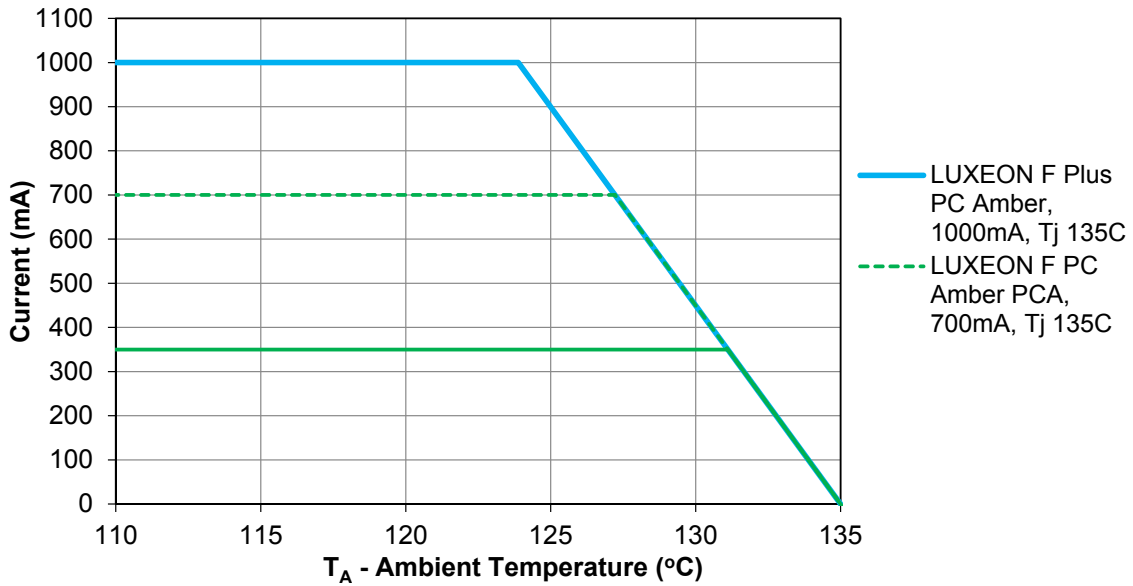

Figure 47. LUXEON F PC Amber & Plus PC Amber Maximum forward current vs Ambient Temperature.

Mounting Thermal resistance (case to heat sink – K/W) is not included ^{[1] [2]}.

Current Derating Curve LUXEON F Cool White & ES Cool White

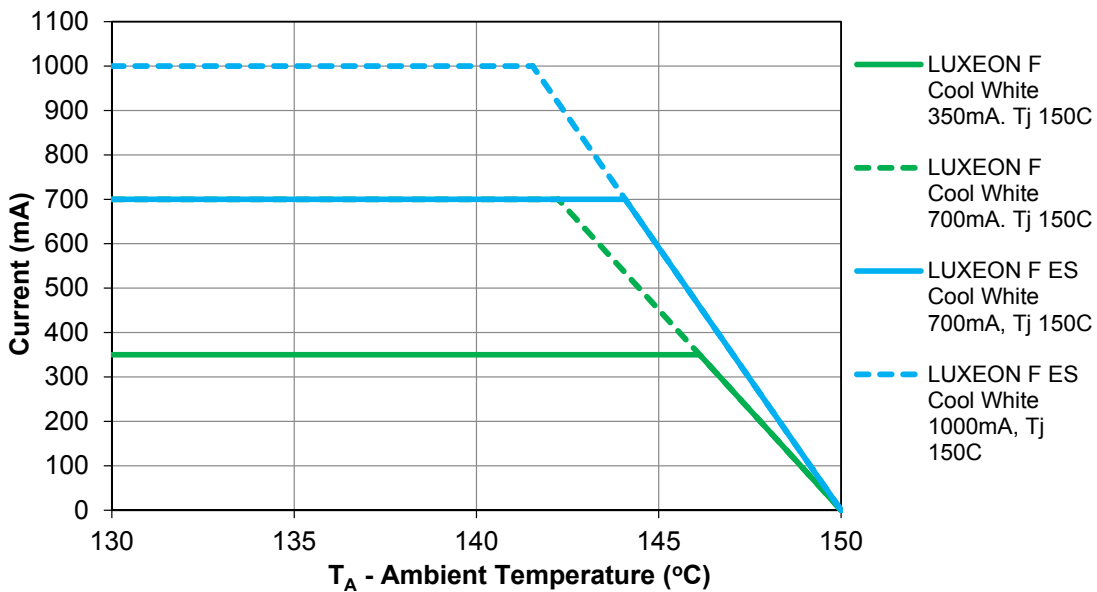

Figure 48. LUXEON F Cool White & ES Cool White Maximum forward current vs Ambient Temperature.

Mounting Thermal resistance (case to heat sink – K/W) is not included ^{[1] [2]}.

Current Derating Curve LUXEON F Plus Cool White & Premium Cool White

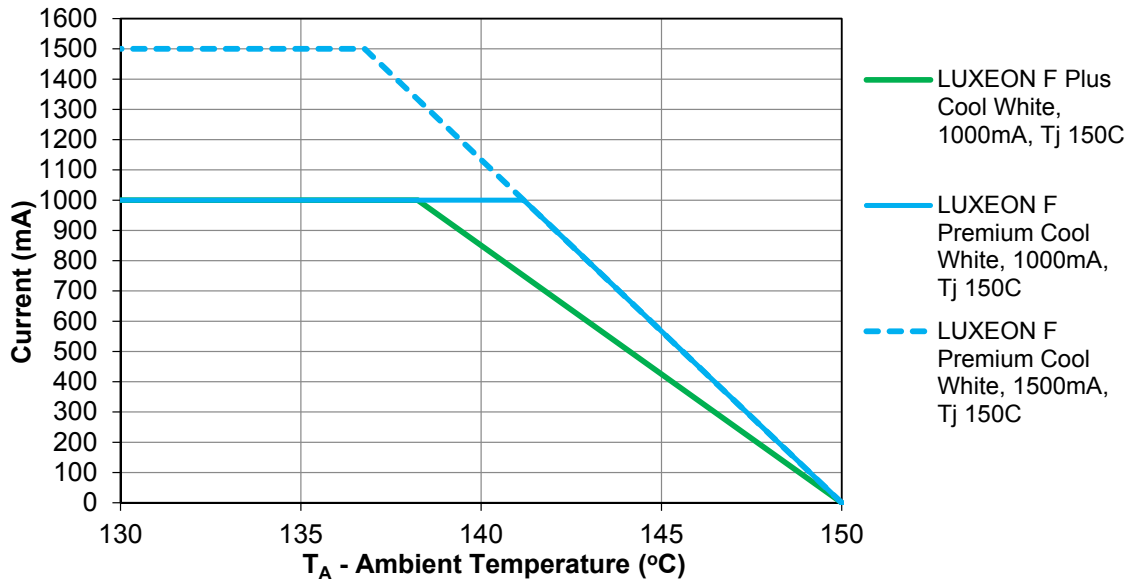

Figure 49. LUXEON F Plus Cool White & Premium Cool White Maximum forward current vs Ambient Temperature. Mounting Thermal resistance (case to heat sink – K/W) is not included ^[1] ^[2].

Note: Figures 47 – 49.

1. Current derating curves represent constant current operation condition.
2. LEDs driven at maximum junction temperature will have shorter lifetimes.

Typical Radiation Pattern LUXEON F PC Amber & Plus PC

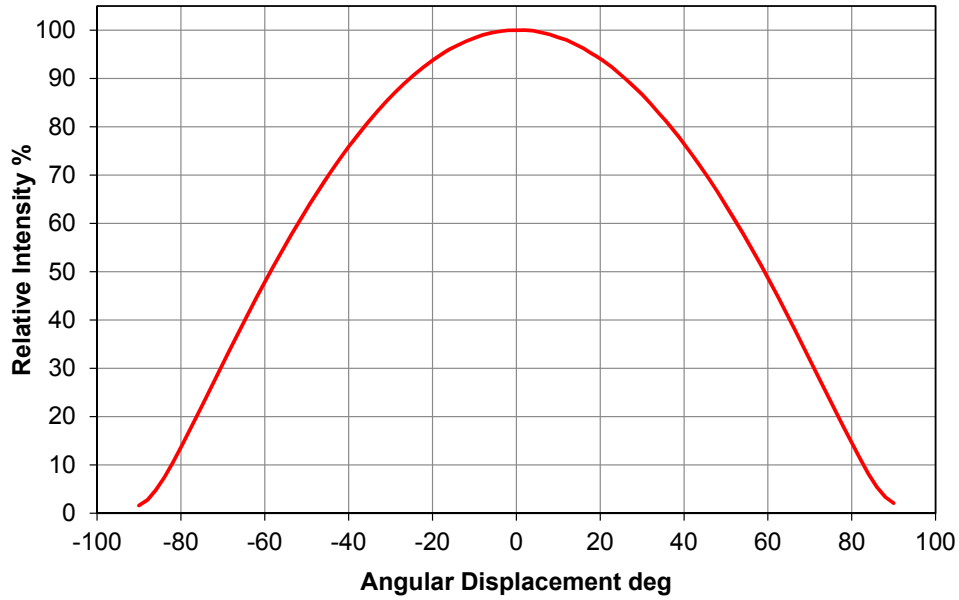

Figure 50. Typical spatial radiation pattern (Intensity) for LUXEON F PC Amber and Plus PC Amber Lambertian in Cartesian Coordinates.

Typical Radiation Pattern LUXEON F Cool White

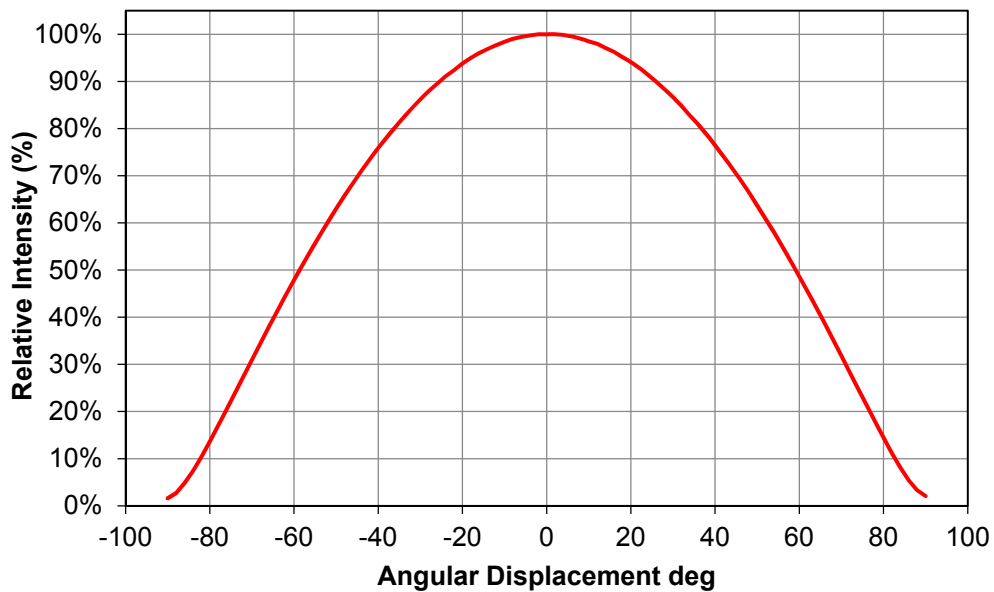

Figure 51. Typical spatial radiation pattern (Intensity) for LUXEON F Cool White Lambertian in Cartesian Coordinates.

Notes for Figure 55 & 56:

1. Current derating curves represent constant current operation condition.
2. LEDs driven at maximum junction temperature will have shorter lifetimes.

Typical Radiation Pattern LUXEON F ES Cool White

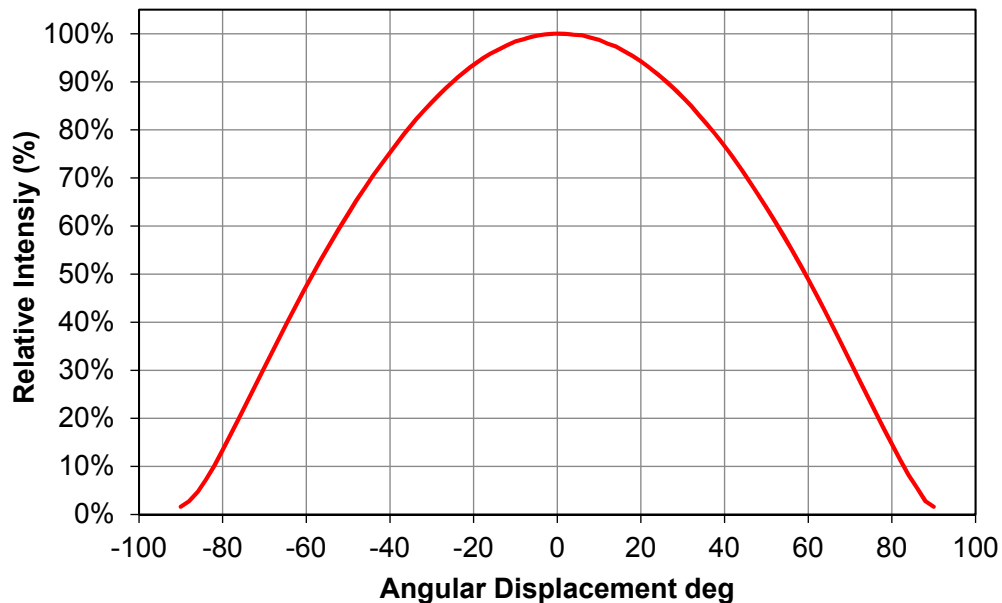

Figure 52. Typical spatial radiation pattern (Intensity) for LUXEON F ES Cool White Lambertian in Cartesian Coordinates.

Typical Radiation Pattern LUXEON F Plus Cool White & Premium Cool White

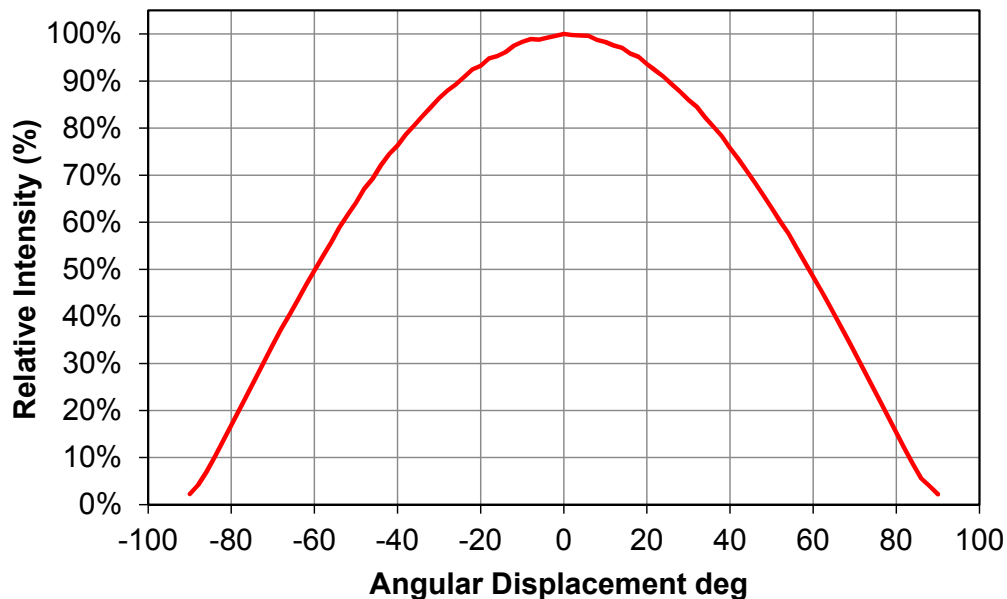

Figure 53. Typical spatial radiation pattern (Intensity) for LUXEON F Plus Cool White and Premium Cool White Lambertian in Cartesian Coordinates.

Emitter Pocket Tape Packaging

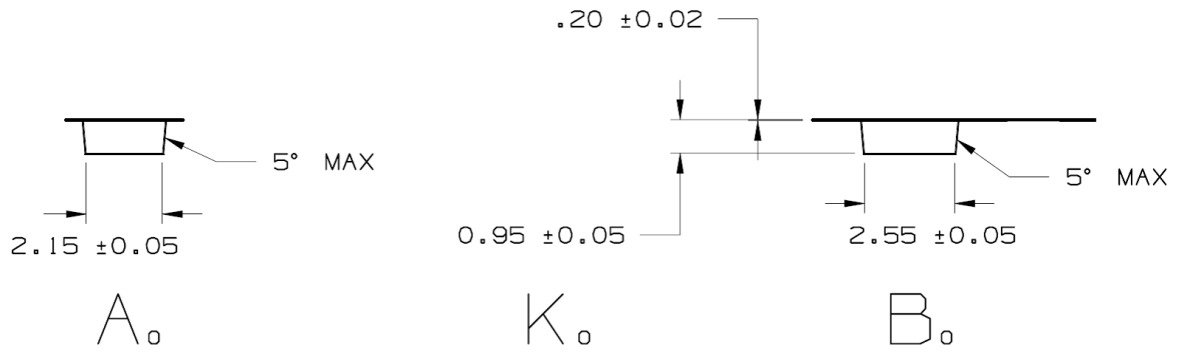
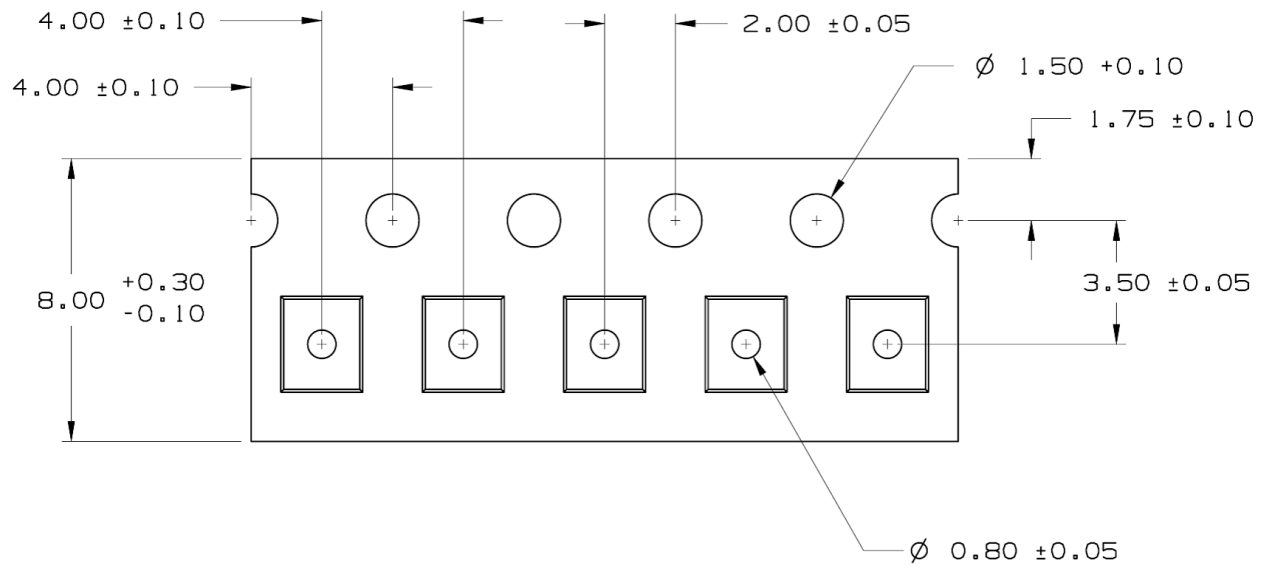
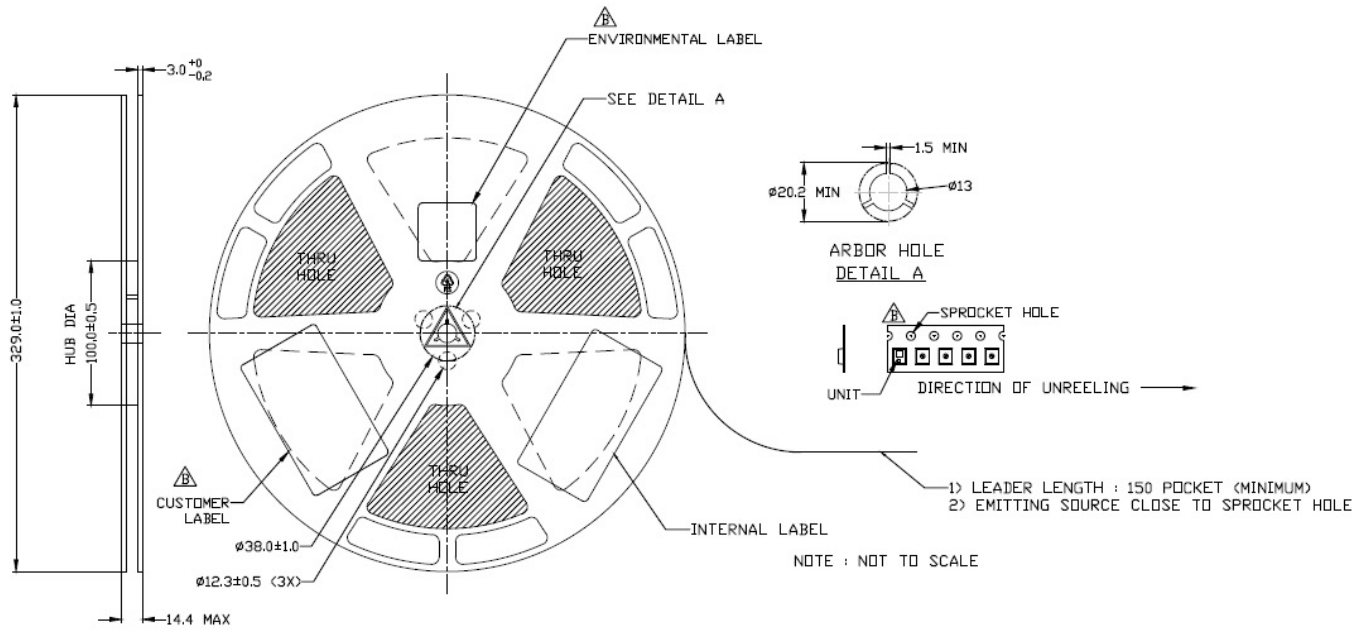

Figure 54. Emitter pocket tape packaging.

Note for Figure 54:

1. All dimensions are in millimeters.
2. A_o is the width of pocket K_o is the depth of pocket. B_o is the height of pocket.

Emitter Reel Packaging



SPI 1000
 SPI is the number of LEDs per reel. For LUXEON F, all reels ship with 1000 LEDs.

TOLERANCES UNLESS OTHERWISE SPECIFIED:

LINEAR	ANGULAR
XXX ± 0.25	XX $\pm 5'$
XXXX ± 0.125	XXX $\pm 30'$
XXXXXX ± 0.0625	XXXX $\pm 10'$ / $30'$

Figure 55. Emitter reel packaging.

- Note for Figure 55:
1. SPI is the number of LEDs per reel.
 2. LUXEON F ships with 1000 LEDs per reel

Emitter Laser Marking

LUXEON F : 2D laser marking coding convention

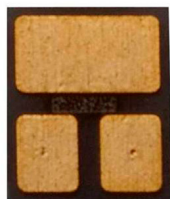

Marking

PYMDDXXXXXXXXCD

14 Chars

P	Y	M	DD	XXXXXXXX	CD
Product (1 char)	Year (1 char) 2010 to 2038	Month (1 char), Jan to Dec	DD (2 chars)	Traceability ID (7 chars)	CAT code (2 chars)
1 to 9 (9), A to Y (18)	0 to 9 (10), A to Y (18)	1 to 9 (9), A, C, D	0 to 9 (10)	1 to 9, A to Y	1 to 9, A to Y C: flux + vf, D: color

P	Product Type
1	CW Premium
2	PC Amber Plus
3	CW
4	CW ES
5	PC Amber
6	CW Plus
7	Red-Orange
8	↓
9	↓
A	↓
C	↓
D	etc

Year (Y)	28 years
0	2010
1	2011
2	2012
8	2018
9	2019
A	2020
C	2021
T	2033
U	2034
V	2037

Month (M)	12 months
1	Jan
2	Feb
3	Mar
4	Apr
5	May
6	Jun
7	Jul
8	Aug
9	Sep
A	Oct
C	Nov
D	Dec

CAT Code (CD)
See Table 7

Figure 56. Emitter laser marking.

Automotive Product Binning and Labeling

Purpose of Product Binning

In the manufacturing of semiconductor products, there is a variation of performance around the average values given in the technical data sheets. For this reason, Lumileds bins the LED components for luminous flux, color and forward voltage (V_F).

Decoding Product Bin Labeling

LUXEON F Emitters are labeled using a four digit alphanumeric code (CAT code) depicting the bin values for emitters packaged on a single reel. All emitters packaged within a reel are of the same 4-variable bin combination. Using these codes it is possible to determine optimum mixing and matching of products for consistency in a given application.

Format of Labeling for Emitters

Reels of LUXEON F Premium Cool White, Plus Cool White and ES Cool White and Cool White Emitters are labeled with a four digit alphanumeric CAT code following the format below.

ABCD

- A = Flux bin (P, Q, R, S, etc.)
- B & C = Color bin (1A, 1B, 1C, 1D... etc.)
- D = V_F bin (A, B,C,D etc.)

Reels of LUXEON F Plus PC Amber and PC Amber Emitters are labeled with a three digit alphanumeric CAT code following the format below.

ABC

- A = Flux bin (P, Q, R, S, etc.)
- B = Color bin (A, B etc.)
- C = V_F bin (A, B,C,D, etc.)

Product Binning and Labeling

85°C DC Luminous Flux Bins

Table 7 lists the standard photometric luminous flux bins for LUXEON F emitters.

Although several bins are outlined, product availability in a particular bin varies by production run and by product performance. Not all bins are available in all colors.

Table 7. Flux Bins ⁽¹⁾

Bin Code	Minimum Luminous Flux (lm)	Maximum Luminous Flux (lm)
A	40	50
B	50	60
C	60	70
D	70	80
E	80	90
F	90	100
G	100	110
H	110	120
J	120	130
K	130	140
L	140	150
M	150	160
N	160	170
P	170	180
Q	180	190
R	190	200
S	200	220
T	220	240
V	240	260
W	260	280
X	280	300
Y	300	320

Note for Table 7:

1. Luminous flux bin structure for LUXEON F emitters.

LUXEON F Cool White Family Bin Structure ^[1]

LUXEON F Cool White Emitters for Automotive applications are tested and binned by x,y coordinates ^[2].

Table 8. Flux Bins ^[1]

Color Bin	x	y	6 Digit IEC Code ³	Typical CCT (K)	Color Bin	x	y	6 Digit IEC Code ³	Typical CCT (K)
2B	0.311961	0.313867	ebvG33	6460	1B	0.312018	0.330596	fbwA23	6390
	0.318494	0.320252				0.316937	0.335312		
	0.319244	0.313051				0.317732	0.327680		
	0.313084	0.306976				0.313080	0.323198		
2D	0.318494	0.320252	ebyG33	6050	1D	0.316937	0.335312	fbyA33	6050
	0.325293	0.326623				0.32457	0.342355		
	0.325646	0.319089				0.324942	0.33438		
	0.319244	0.313051				0.317732	0.32768		
4B	0.325293	0.326623	ecbG33	5680	3B	0.32457	0.342355	fcbA33	5680
	0.332332	0.332924				0.332475	0.349338		
	0.33228	0.325087				0.332407	0.341014		
	0.325646	0.319089				0.324942	0.33438		
4D	0.332332	0.332924	eceG33	5350	3D	0.332475	0.349338	fceA33	5350
	0.33964	0.339175				0.340641	0.356212		
	0.339158	0.331035				0.340128	0.347552		
	0.33228	0.325087				0.332407	0.341014		
2A	0.310868	0.321066	ebvD33	6460	1A	0.310934	0.33823	fbwD23	6390
	0.317732	0.32768				0.316129	0.34319		
	0.318494	0.320252				0.316937	0.335312		
	0.311961	0.313867				0.312018	0.330596		
2C	0.317732	0.32768	ebyD33	6050	1C	0.316129	0.34319	fbyD33	6050
	0.324942	0.33438				0.324184	0.350596		
	0.325293	0.326623				0.32457	0.342355		
	0.318494	0.320252				0.316937	0.335312		
4A	0.324942	0.33438	ecbD33	5680	3A	0.324184	0.350596	fcbD33	5680
	0.332407	0.341014				0.332532	0.357928		
	0.332332	0.332924				0.332475	0.349338		
	0.325293	0.326623				0.32457	0.342355		
4C	0.332407	0.341014	eceD33	5350	3C	0.332532	0.357928	fceD33	5350
	0.340128	0.347552				0.341158	0.365155		
	0.33964	0.339175				0.340641	0.356212		
	0.332332	0.332924				0.332475	0.349338		

Notes for Table 8:

1. Lumileds maintains a tester tolerance of ± 0.005 on x, y color coordinates.
2. CIE 1931 x and y coordinate frame.
3. IEC/ PAS 62707-1

Automotive Product Binning and Labeling

Graphical Presentation of LUXEON F Cool White Family x, y Color Bin Coordinates

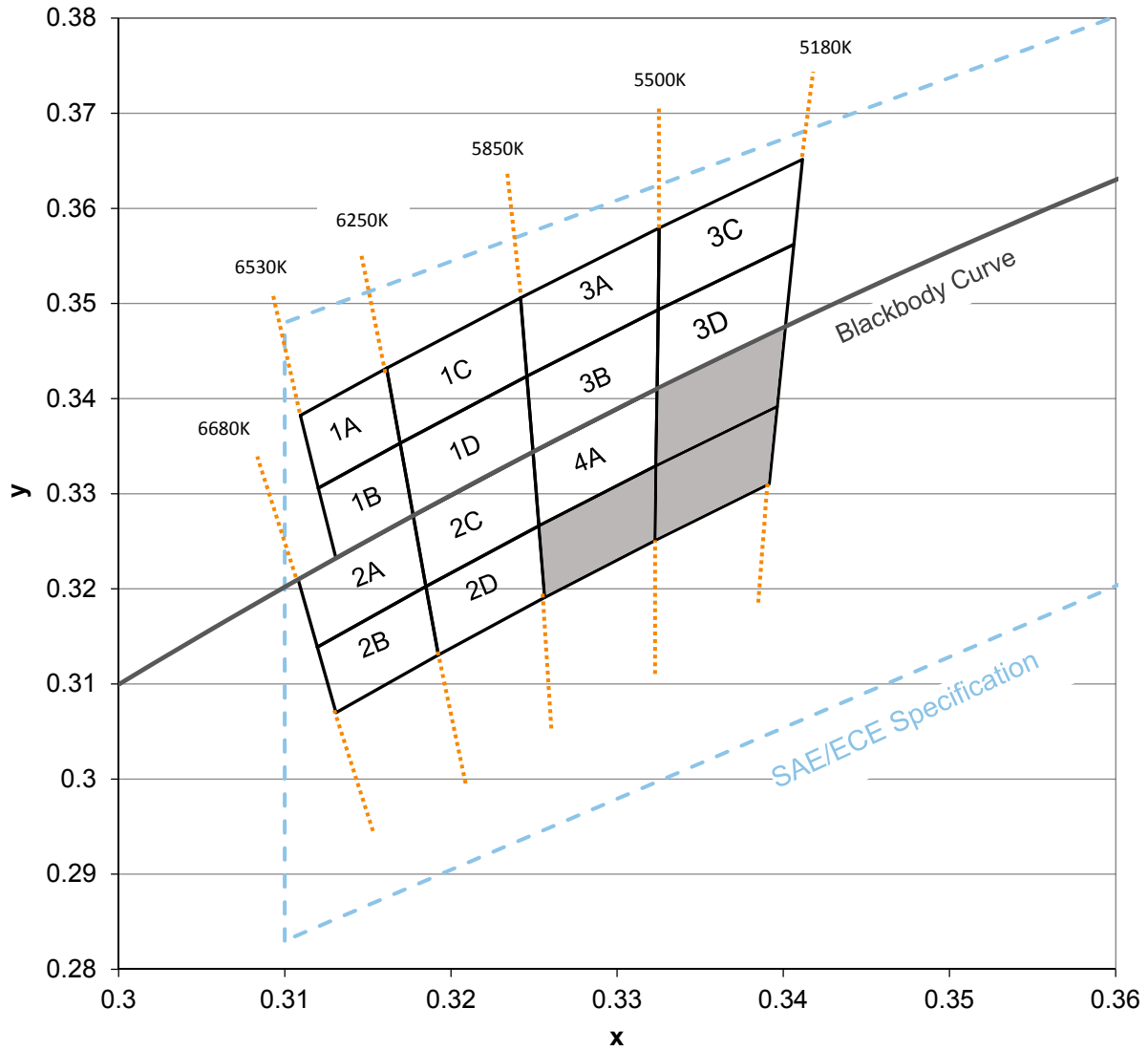

Figure 57. LUXEON F Cool White family binning structure.

Binning is program specific and will be finalized upon mutual agreement and confirmation of supportability by Lumileds.

Product Binning and Labeling

LUXEON F Plus PC Amber and PC Amber Family Color Bin Structure

LUXEON F PC Amber Emitters for Automotive applications are tested and binned by x,y coordinates.

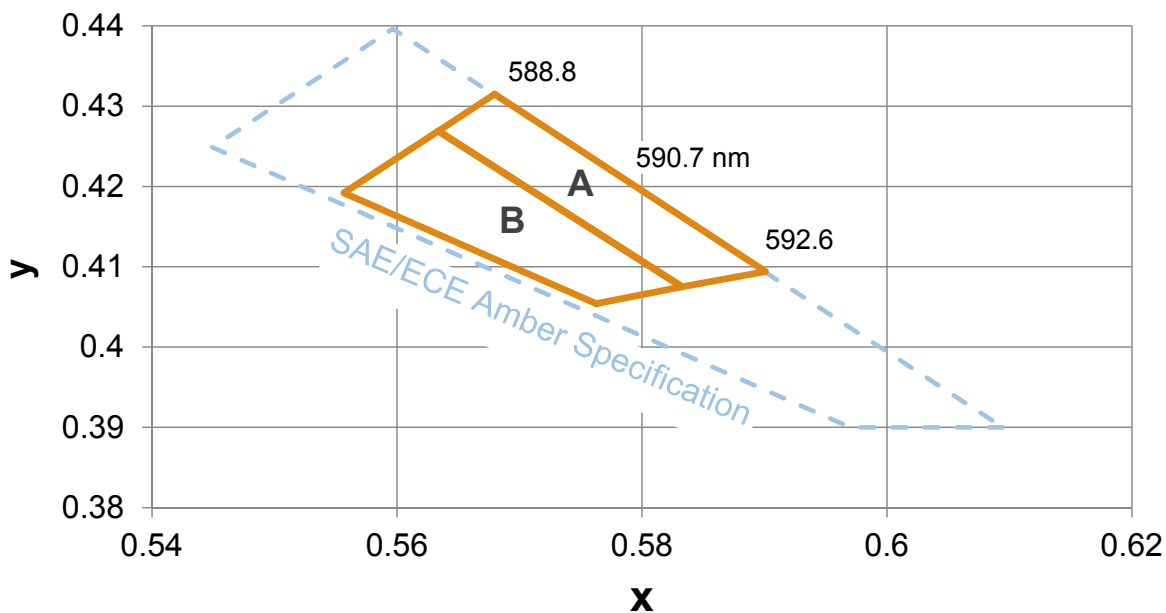

Figure 58. LUXEON F PC Amber family binning structure.

Table 9. LUXEON F PC Amber Family Bin coordinates ^[1] ^[2] ^[3]

Color Bin	x	y
A	0.5680	0.4315
	0.5634	0.4269
	0.5833	0.4075
	0.5901	0.4094
B	0.5763	0.4054
	0.5833	0.4075
	0.5634	0.4269
	0.5557	0.4192

Note for Table 9:

1. LUXEON F PC Amber emitters are tested and binned by x,y color coordinates.
2. Lumileds maintains a tester tolerance of ± 0.005 on x, y color coordinates.
3. Test conditions at test current with a pulse duration of 20ms.

Forward Voltage Bins

Table 10 lists minimum and maximum V_f bin values per emitter. Although several bins are outlined, product availability in a particular bin varies by production run and by product performance.

Table 10. V_f Bins^[1]

Bin Code	Minimum Forward Voltage (V)	Maximum Forward Voltage (V)
B	2.55	2.79
C	2.79	3.03
D	3.03	3.27

Note for Table 10:

1. Forward voltage bin structure for all LUXEON F Emitters (Premium Cool White, Cool White, Cool White ES, Plus PC Amber and PC Amber)

About Lumileds

Lumileds is the light engine leader, delivering innovation, quality, and reliability.

For 100 years, Lumileds commitment to innovation has helped customers pioneer breakthrough products in the automotive, consumer and illumination markets.

Lumileds is shaping the future of light with our LEDs and automotive lamps, and helping our customers illuminate how people see the world around them.

To learn more about our portfolio of light engines visit www.lumileds.com.



©2015 Lumileds Holding B.V. All rights reserved.
LUXEON is a registered trademark of the Lumileds Holding B.V.
in the United States and other countries.

www.lumileds.com

Neither Lumileds Holding B.V. nor its affiliates shall be liable for any kind of loss of data or any other damages, direct, indirect or consequential, resulting from the use of the provided information and data. Although Lumileds Holding B.V. and/or its affiliates have attempted to provide the most accurate information and data, the materials and services information and data are provided "as is," and neither Lumileds Holding B.V. nor its affiliates warrants or guarantees the contents and correctness of the provided information and data. Lumileds Holding B.V. and its affiliates reserve the right to make changes without notice. You as user agree to this disclaimer and user agreement with the download or use of the provided materials, information and data.