



LUXEON 3535L Color Line

Color LEDs that deliver the perfect amount of color you need. No More. No less.

The LUXEON 3535L Color Line enables a new era of color lighting. This robust color line provides high performance and is targeted at cost effective designs. Complemented by a broad range of white offerings, the LUXEON 3535L Color Line enables RGBW applications. This product line extends the comprehensive LUXEON Color Family.



FEATURES AND BENEFITS

Industry standard package enables drop-in replacement for existing 3535 packages

Single die and single source architecture for optical control

Common focal length with LUXEON Rebel and LUXEON Z Color LEDs

Full color palette for a wider spectrum range

PRIMARY APPLICATIONS

Architectural & Entertainment

Lamps

- Color Tunable Illumination

Specialty Lighting

- Emergency Vehicle

- Signage

Table of Contents

General Product Information	2
Product Test Conditions	2
Part Number Nomenclature	2
Lumen Maintenance	2
Environmental Compliance	2
Performance Characteristics	3
Product Selection Guide	3
Optical Characteristics	3
Electrical and Thermal Characteristics	4
Absolute Maximum Ratings	4
Characteristic Curves	5
Spectral Power Distribution Characteristics	5
Light Output Characteristics	5
Forward Current Characteristics	8
Radiation Pattern Characteristics	9
Product Bin and Labeling Definitions	10
Decoding Product Bin Labeling	10
Luminous Flux Bins	11
Radiometric Power Bins	11
Dominant Wavelength Bins	12
Peak Wavelength Bins	12
Color Bin Definitions	13
Forward Voltage Bins	14
Mechanical Dimensions	14
Reflow Soldering Guidelines	15
JEDEC Moisture Sensitivity	15
Solder Pad Design	16
Packaging Information	16
Pocket Tape Dimensions	16
Reel Dimensions	17

General Product Information

Product Test Conditions

LUXEON 3535L Color Line LEDs are tested and binned with a 20ms monopulse of 100mA at a junction temperature, T_j , of 25°C.

Part Number Nomenclature

Part numbers for LUXEON 3535L Color Line follow the convention below:

L 1 3 5 – **A A A A** 0 0 3 5 0 0 0 0 **B**

Where:

A A A A – designates color (R625=Red, O615=Red Orange, A589=PC Amber, L567=Lime, G525=Green, B475=Blue, U450=Royal Blue)

B – designates a Lumileds internal code (either 0 or 1)

Therefore, the following part number is used for a Red LUXEON 3535L:

L 1 3 5 – **R 6 2 5** 0 0 3 5 0 0 0 0 **0**

Lumen Maintenance

Please contact your local Sales Representative or Lumileds Technical Solutions Manager for more information about the long-term performance of this product.

Environmental Compliance

Lumileds LLC is committed to providing environmentally friendly products to the solid-state lighting market. LUXEON 3535L Color Line is compliant to the European Union directives on the restriction of hazardous substances in electronic equipment, namely the RoHS Directive 2011/65/EU and REACH Regulation (EC) 1907/2006. Lumileds LLC will not intentionally add the following restricted materials to its products: lead, mercury, cadmium, hexavalent chromium, polybrominated biphenyls (PBB) or polybrominated diphenyl ethers (PBDE).

Performance Characteristics

Product Selection Guide

Table 1. Product performance of LUXEON 3535L Color Line at 100mA, T_j=25°C.

COLOR	DOMINANT or PEAK WAVELENGTH ^[1] (nm)		LUMINOUS FLUX ^[2] (lm) or RADIOMETRIC POWER ^[3] (mW)		PART NUMBER
	MINIMUM	MAXIMUM	MINIMUM	TYPICAL	
Red	620	630	10.0	13.5	L135-R625003500000
Red-Orange	610	620	13.0	15.5	L135-O615003500000
PC Amber	-	-	24.0	35.0	L135-A589003500000
Lime	-	-	44.0	56.0	L135-L567003500000
Green	520	540	21.0	35.0	L135-G525003500000
Blue	469	480	8.2	11.0	L135-B475003500000
Royal Blue	440	455	130	155	L135-U450003500000

Notes for Table 1:

- Lumileds maintains a tolerance of ±1nm on dominant wavelength measurements. PC Amber and Lime are binned by chromaticity coordinates. Royal Blue is binned by peak wavelength. All other colors are binned by dominant wavelength.
- Lumileds maintains a tolerance of ±7.5% on luminous flux measurements.
- Royal Blue is binned by radiometric power. All other colors are binned by luminous flux.

Optical Characteristics

Table 2. Optical characteristics for LUXEON 3535L Color Line at 100mA, T_j=25°C.

COLOR	PART NUMBER	TYPICAL SPECTRAL HALF-WIDTH ^[1] (nm)	TYPICAL TEMPERATURE COEFFICIENT OF DOMINANT WAVELENGTH (nm/°C)	TYPICAL TOTAL INCLUDED ANGLE ^[2]	TYPICAL VIEWING ANGLE ^[3]
Red	L135-R625003500000	20	0.04	140°	115°
Red-Orange	L135-O615003500000	20	0.07	140°	115°
PC Amber	L135-A589003500000	95	0.01	140°	115°
Lime	L135-L567003500000	110	0.01	140°	115°
Green	L135-G525003500000	35	0.04	140°	115°
Blue	L135-B475003500000	25	0.04	140°	115°
Royal Blue	L135-U450003500000	25	0.04	140°	115°

Notes for Table 2:

- Spectral half-width is the spectral bandwidth at 50% of the peak intensity
- Total angle at which 90% of total luminous flux is captured.
- Viewing angle is the off axis angle from the LED centerline where the luminous intensity is ½ of the peak value.

Electrical and Thermal Characteristics

Table 3. Electrical and thermal characteristics for LUXEON 3535L Color Line at 100mA, T_j=25°C.

COLOR	PART NUMBER	FORWARD VOLTAGE ^[1] (V)			TYPICAL TEMPERATURE COEFFICIENT OF FORWARD VOLTAGE ^[2] (mV/°C)	TYPICAL THERMAL RESISTANCE — JUNCTION TO SOLDER PAD (°C/W)
		MINIMUM	TYPICAL	MAXIMUM		
Red	L135-R625003500000	1.75	2.10	2.50	-2.0	20
Red-Orange	L135-O615003500000	1.75	2.10	2.50	-1.7	20
PC Amber	L135-A589003500000	2.80	3.05	3.50	-1.7	25
Lime	L135-L567003500000	2.80	3.05	3.50	-1.7	25
Green	L135-G525003500000	2.50	3.20	3.50	-3.0	42
Blue	L135-B475003500000	2.50	3.00	3.50	-2.5	35
Royal Blue	L135-U450003500000	2.50	3.05	3.50	-2.5	35

Notes for Table 3:

1. Lumileds maintains a tolerance of ±0.1V on forward voltage measurements.
2. Measured between 25°C and 85°C.

Absolute Maximum Ratings

Table 4. Absolute maximum ratings for LUXEON 3535L Color Line.

PARAMETER	RED AND RED-ORANGE	PC AMBER AND LIME	GREEN	BLUE AND ROYAL BLUE
DC Forward Current ^[1,2]	125mA	200mA	200mA	200mA
Peak Pulsed Forward Current ^[1,3]	300mA	240mA	300mA	480mA
LED Junction Temperature ^[1] (DC & Pulse)	125°C	125°C	115°C	125°C
ESD Sensitivity (ANSI/ESDA/JEDEC JS-001-2012)	Class 2	Class 2	Class 2	Class 2
Operating Case Temperature ^[1]	105°C	105°C	95°C	95°C
LED Storage Temperature	-40°C to 105°C	-40°C to 105°C	-40°C to 95°C	-40°C to 95°C
Soldering Temperature	JEDEC 020c 260°C			
Allowable Reflow Cycles	3			
Reverse Voltage (V _{reverse})	LUXEON LEDs are not designed to be driven in reverse bias			

Notes for Table 4:

1. Proper current derating must be observed to maintain the junction temperature below the maximum allowable junction temperature.
2. Residual periodic variations due to power conversion from alternating current (AC) to direct current (DC), also called "ripple," are acceptable if the following conditions are met:
 - The frequency of the ripple current is 100Hz or higher
 - The average current for each cycle does not exceed the maximum allowable DC forward current
 - The maximum amplitude of the ripple does not exceed the maximum peak pulsed forward current
3. At 10% duty cycle with pulse width of 10ms.

Characteristic Curves

Spectral Power Distribution Characteristics

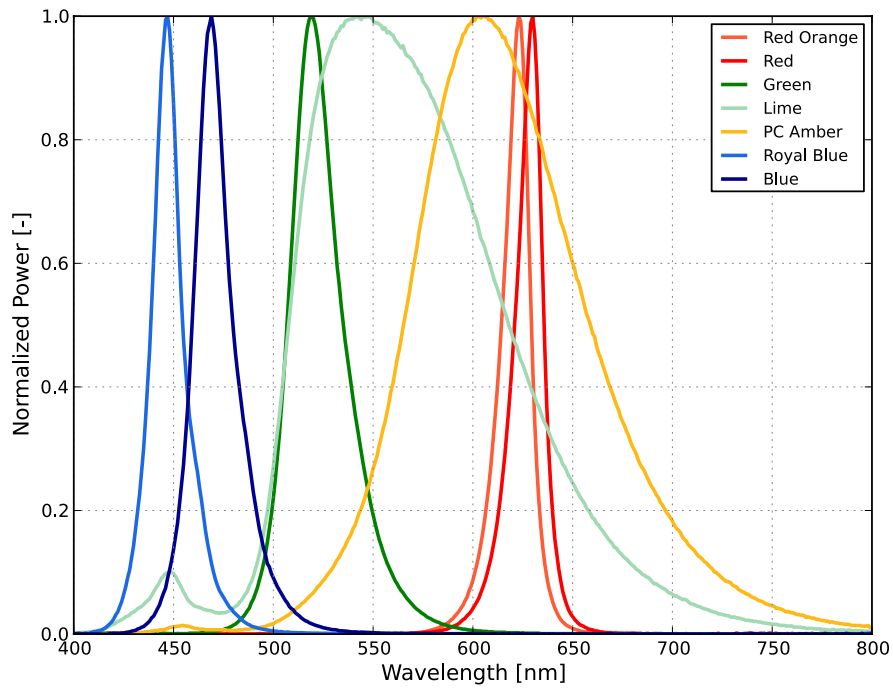

Figure 1. Typical normalized power vs. wavelength for LUXEON 3535L Color Line at 100mA, $T_j=25^{\circ}\text{C}$.

Light Output Characteristics

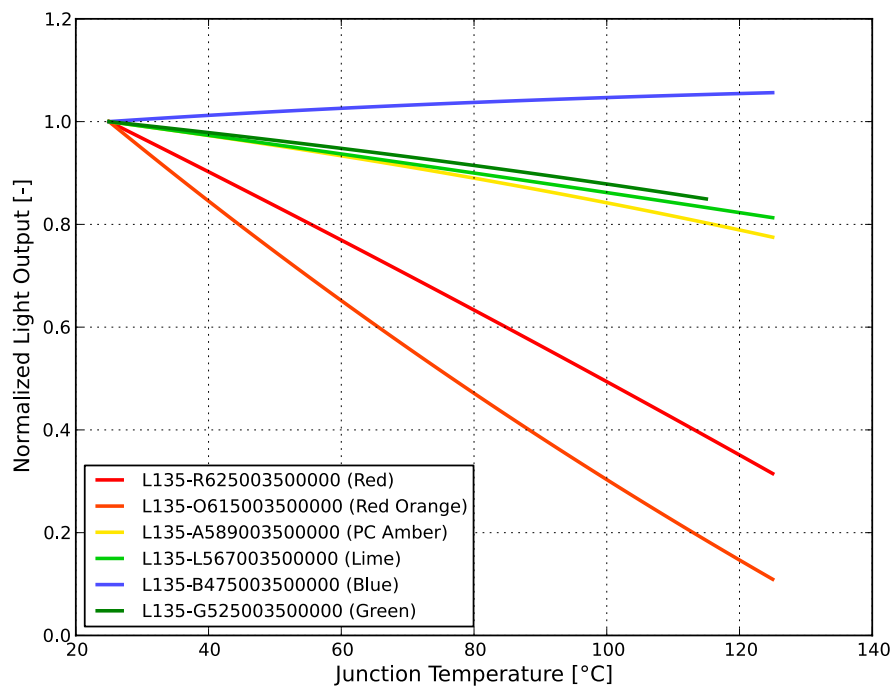

Figure 2a. Typical normalized light output vs. junction temperature for LUXEON 3535L Red, Red-Orange, PC Amber, Lime, Blue, Green at 100mA.

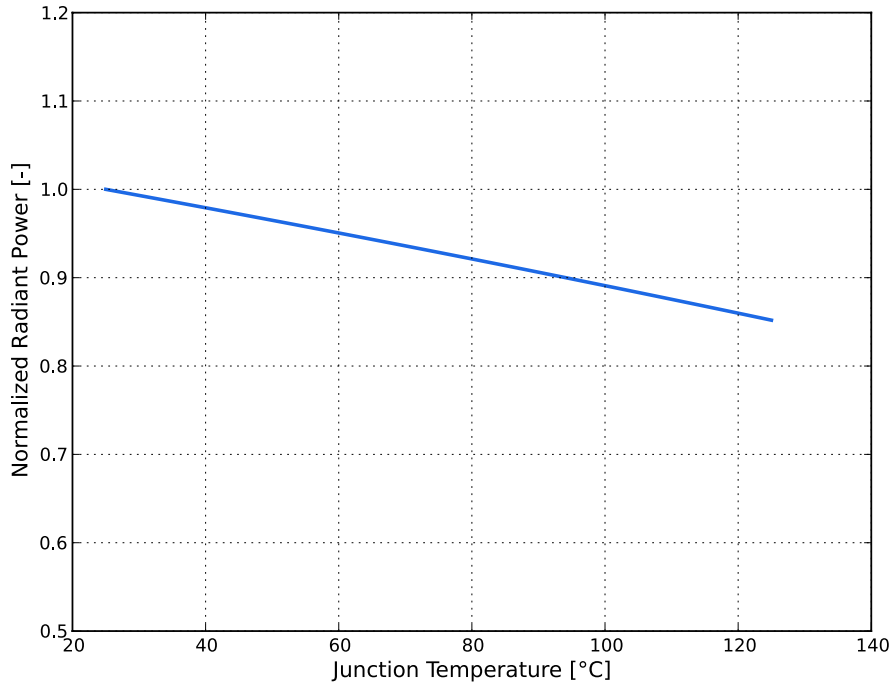

Figure 2b. Typical normalized light output vs. junction temperature for LUXEON 3535L Royal Blue at 100mA.

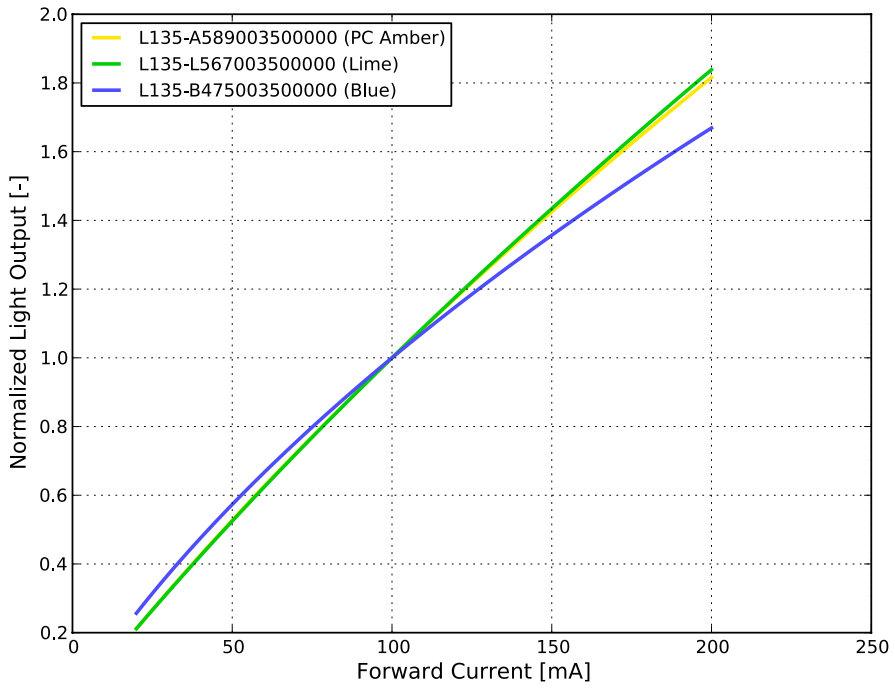

Figure 3a. Typical normalized light output vs. forward current for LUXEON 3535L PC Amber, Lime and Blue at $T_j=25^\circ\text{C}$.

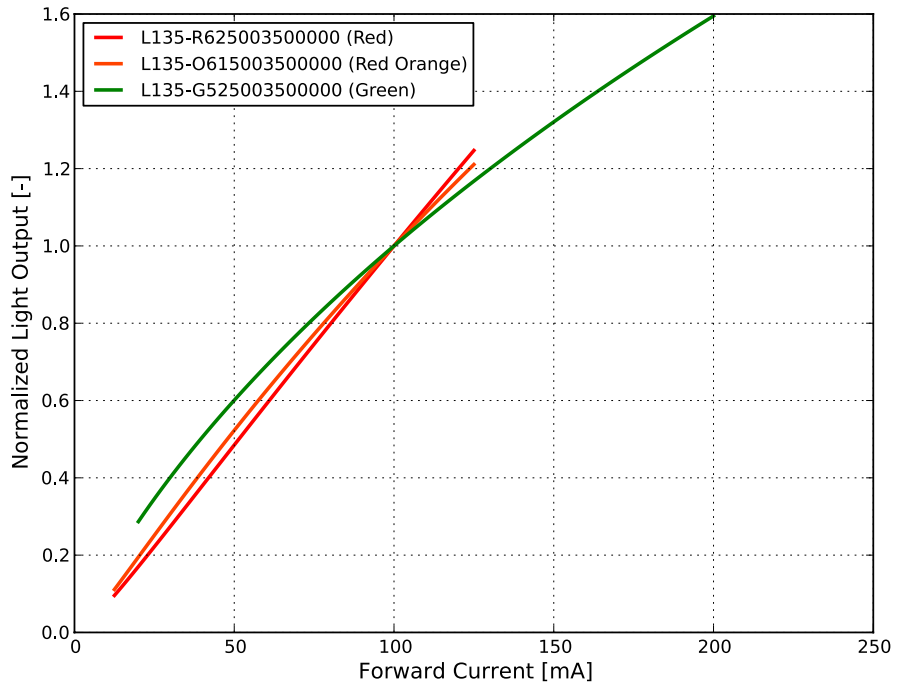

Figure 3b. Typical normalized light output vs. forward current for LUXEON 3535L Red, Red-Orange, Green at $T_j=25^\circ\text{C}$.

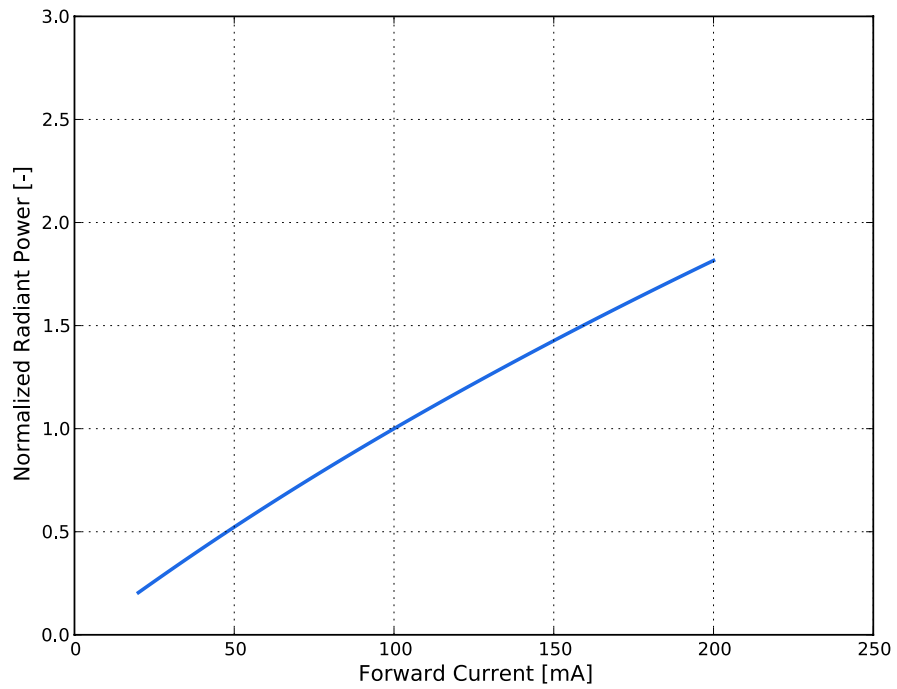

Figure 3c. Typical normalized light output vs. forward current for LUXEON 3535L Royal Blue at $T_j=25^\circ\text{C}$.

Forward Current Characteristics

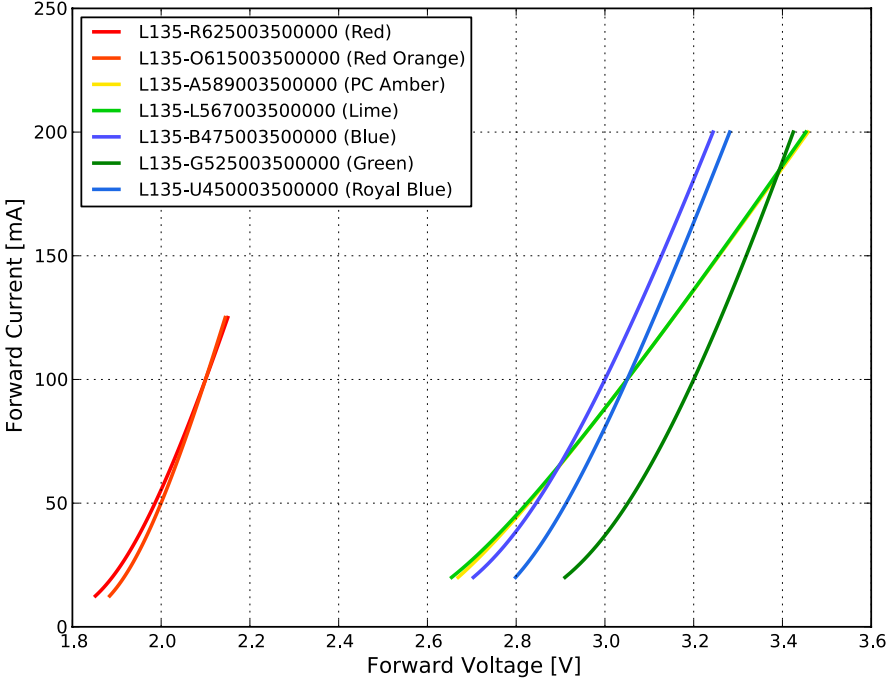

Figure 4. Typical forward current vs. forward voltage for LUXEON 3535L Color Line at $T_j=25^\circ\text{C}$.

Radiation Pattern Characteristics

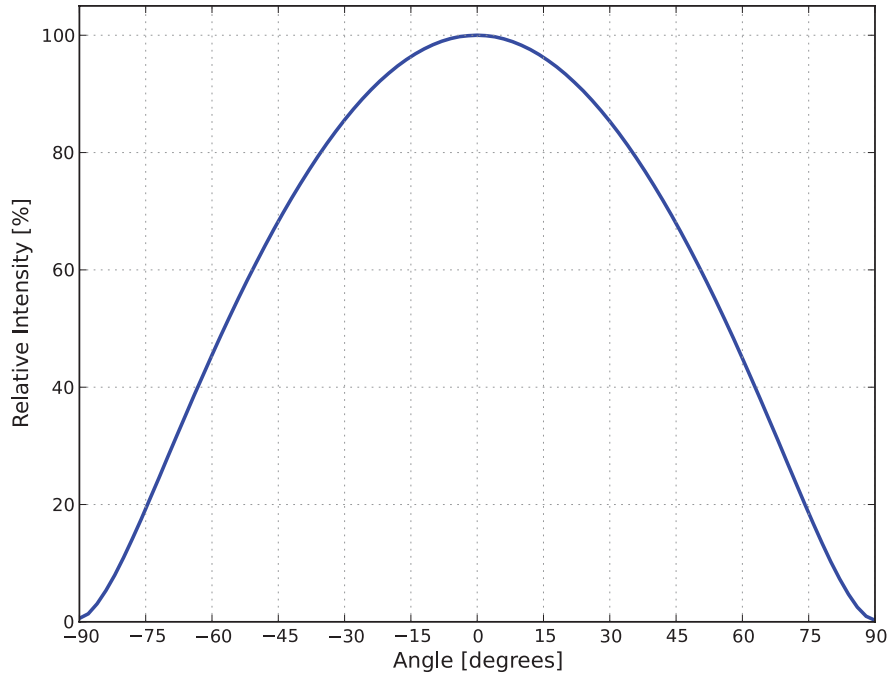

Figure 5. Typical radiation pattern for LUXEON 3535L Color Line at 100mA, $T_j=25^{\circ}\text{C}$.

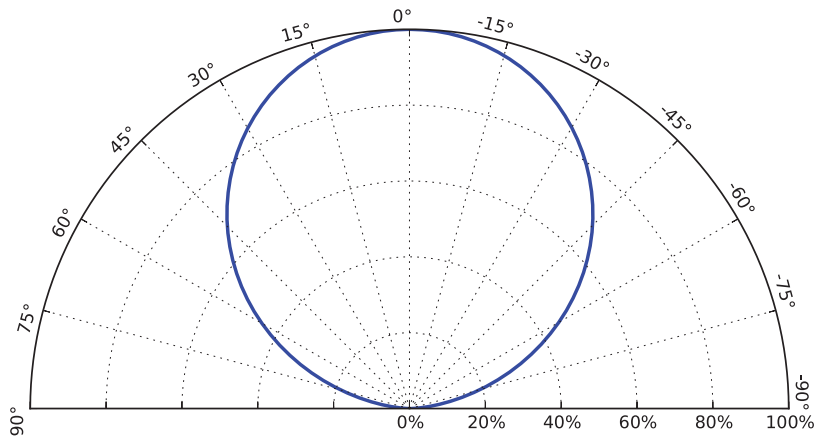

Figure 6. Typical polar radiation pattern for LUXEON 3535L Color Line at 100mA, $T_j=25^{\circ}\text{C}$.

Product Bin and Labeling Definitions

Decoding Product Bin Labeling

In the manufacturing of semiconductor products, there are variations in performance around the average values given in the technical datasheet. For this reason, Lumileds bins LED components for luminous flux or radiometric power, color point, peak or dominant wavelength and forward voltage.

LUXEON 3535L Red, Red-Orange, Green, Blue and Royal Blue LEDs are labeled using a 3-digit alphanumeric CAT code following the format below:

A B C

Where:

- A** – designates luminous flux bin (example: L=32.0 to 36.0 lumens, R=48.0 to 52.0 lumens)
- B** – designates radiometric bin (example: B, C, D, E, F, G, H) or dominant/peak wavelength bin (example: 1, 2, 3, 4, 5)
- C** – designates forward voltage bin (example: C=2.00 to 2.25V, G=3.00 to 3.25V)

Therefore, a Red-Orange LUXEON 3535L LED with a lumen range of 15.0 to 17.0, dominant wavelength range of 610 to 620nm and a forward voltage range of 2.00 to 2.25V has the following CAT code:

E 2 C

LUXEON 3535L PC Amber and Lime LEDs are labeled using a 4-digit alphanumeric CAT code following the format below:

A B C D

Where:

- A** – designates luminous flux bin (example: L=32.0 to 36.0 lumens, R=48.0 to 52.0 lumens)
- B C** – designates color bin (example: A0, L0 or L1)
- D** – designates forward voltage bin (example: W=3.00 to 3.10V, Z=3.30 to 3.50V)

Therefore, a Lime LUXEON 3535L LED with a lumen range of 32.0 to 36.0, color bin of L0 and a forward voltage range of 3.00 to 3.10V has the following CAT code:

L L 0 W

Luminous Flux Bins

Table 5 lists the standard luminous flux bins for LUXEON 3535L Color Line emitters. Although several bins are outlined, product availability in a particular bin varies by production run and by product performance. Not all bins are available in all CCTs.

Table 5. Luminous flux bin definitions for LUXEON 3535L Color Line, at $T_j=25^\circ\text{C}$.

BIN	LUMINOUS FLUX ^[1] (lm)	
	MINIMUM	MAXIMUM
A	8.2	10.0
B	10.0	11.5
C	11.5	13.0
D	13.0	15.0
E	15.0	17.0
F	17.0	19.0
G	19.0	21.0
H	21.0	24.0
J	24.0	28.0
K	28.0	32.0
L	32.0	36.0
M	36.0	40.0
P	40.0	44.0
Q	44.0	48.0
R	48.0	52.0
S	52.0	56.0
T	56.0	60.0
V	60.0	65.0
W	65.0	70.0

Notes for Table 5:

1. Lumileds maintains a tolerance of $\pm 7.5\%$ on luminous flux measurements.

Radiometric Power Bins

Table 6. Radiometric power bin definitions for LUXEON 3535L Color Line.

BIN	RADIOMETRIC POWER ^[1] (mW)	
	MINIMUM	MAXIMUM
B	130	140
C	140	150
D	150	160
E	160	170
F	170	180
G	180	190
H	190	200

Notes for Table 6:

1. Lumileds maintains a tolerance of $\pm 6.5\%$ on radiometric power measurements.

Dominant Wavelength Bins

Table 7. Dominant wavelength bin definitions for LUXEON 3535L Red, Red-Orange, Green and Blue.

COLOR	PART NUMBER	BIN	DOMINANT WAVELENGTH ^[1] (nm)	
			MINIMUM	MAXIMUM
Red	L135-R625003500000	4	620	630
Red-Orange	L135-O615003500000	2	610	620
Green	L135-G525003500000	1	520	525
		2	525	530
		3	530	535
		4	535	540
Blue	L135-B475003500000	3	469	475
		4	475	480

Notes for Table 7:

1. Lumileds maintains a tolerance of ± 1 nm on dominant wavelength measurements.

Peak Wavelength Bins

Table 8. Peak wavelength bin definitions for LUXEON 3535L Royal Blue.

COLOR	PART NUMBER	BIN	PEAK WAVELENGTH ^[1] (nm)	
			MINIMUM	MAXIMUM
Royal Blue	L135-U450003500000	3	440	445
		4	445	450
		5	450	455

Notes for Table 8:

1. Lumileds maintains a tolerance of ± 0.5 nm on peak wavelength measurements.

Color Bin Definitions

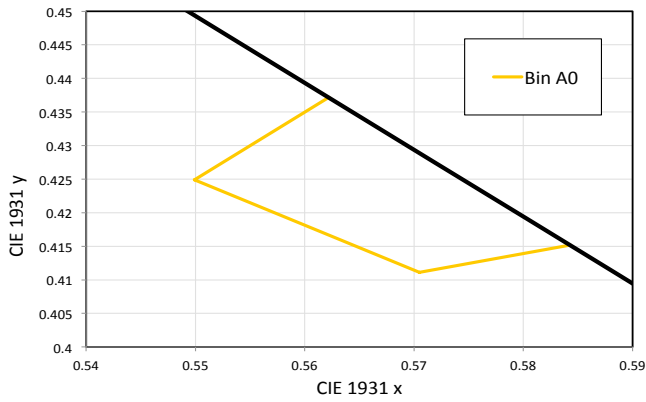

Figure 7. Color Bin Structure for LUXEON 3535L PC Amber for Table 9.

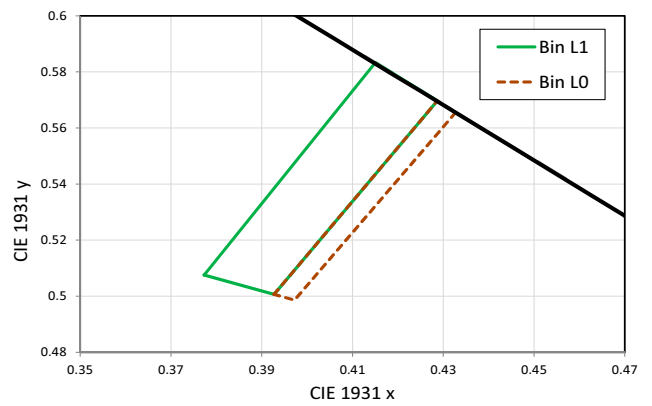

Figure 8. Color Bin Structure for LUXEON 3535L Lime for Table 9.

Table 9. Color bin definitions for LUXEON 3535L PC Amber and Lime.

COLOR	PART NUMBER	BIN	x	y
PC Amber	L135-A589003500000	A0	0.5622	0.4372
			0.5843	0.4152
			0.5705	0.4111
			0.5499	0.4249
Lime	L135-L567003500000	L0	0.3927	0.5007
			0.4287	0.5697
			0.4327	0.5655
			0.3972	0.4986
		L1	0.3773	0.5076
			0.3927	0.5007
			0.4287	0.5697
			0.4150	0.5833

Notes for Table 9:

1. Lumileds maintains a tolerance of ± 0.01 on x and y coordinates in the CIE 1931 color space.

Forward Voltage Bins

Table 10a. Forward voltage bin definitions for LUXEON 3535L Red, Red-Orange, Green, Blue and Royal Blue.

BIN	FORWARD VOLTAGE ⁽¹⁾ (V _f)	
	MINIMUM	MAXIMUM
A	1.50	1.75
B	1.75	2.00
C	2.00	2.25
D	2.25	2.50
E	2.50	2.75
F	2.75	3.00
G	3.00	3.25
H	3.25	3.50

Table 10b. Forward voltage bin definitions for LUXEON 3535L PC Amber and Lime.

BIN	FORWARD VOLTAGE ⁽¹⁾ (V _f)	
	MINIMUM	MAXIMUM
T	2.80	2.90
V	2.90	3.00
W	3.00	3.10
X	3.10	3.20
Y	3.20	3.30
Z	3.30	3.50

Notes for Tables 10a and 10b:

1. Lumileds maintains a tolerance of ±0.1V on forward voltage measurements.

Mechanical Dimensions

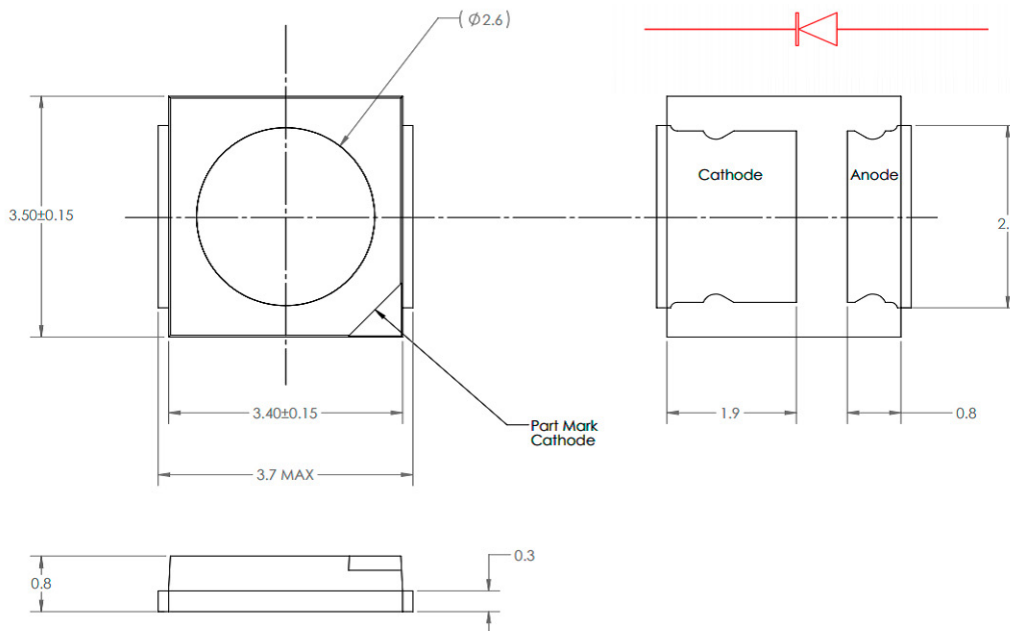

Figure 9. Mechanical dimensions for LUXEON 3535L Color Line.

Notes for Figure 9:

1. Drawings are not to scale.
2. All dimensions are in millimeters.
3. Tolerance of ±0.1mm.

Reflow Soldering Guidelines

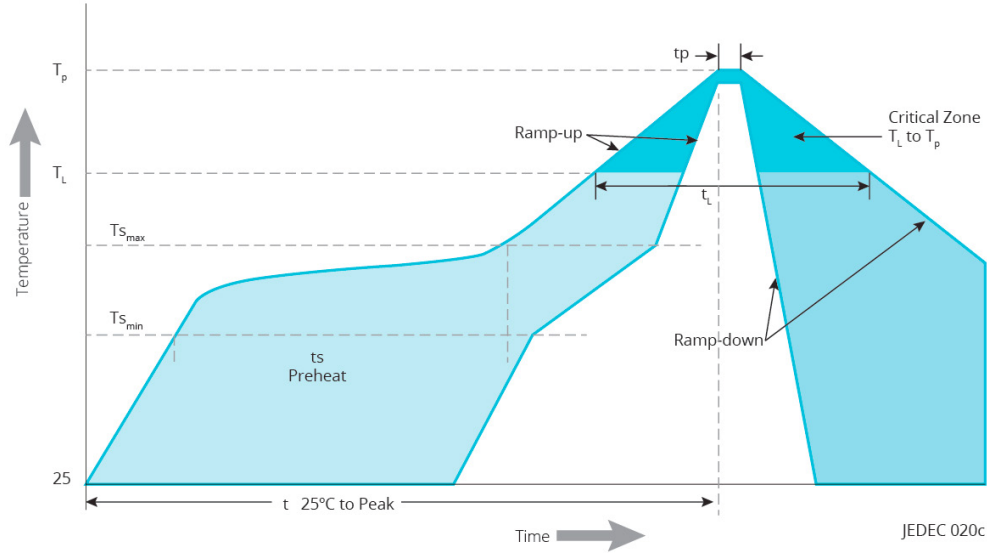

Figure 10. Visualization of the acceptable reflow temperature profile as specified in Table 11.

Table 11. Reflow profile characteristics for LUXEON 3535L Color Line.

PROFILE FEATURE	LEAD-FREE ASSEMBLY
Preheat Minimum Temperature (T_{smin})	150°C
Preheat Maximum Temperature (T_{smax})	200°C
Preheat Time (t_{smin} to t_{smax})	60 to 120 seconds
Ramp-Up Rate (T_L to T_p)	3°C / second maximum
Liquidus Temperature (T_L)	217°C
Time Maintained Above Temperature T_L (t_L)	10 to 30 seconds
Peak / Classification Temperature (T_p)	260°C
Time Within 5°C of Actual Temperature (t_p)	30 seconds
Ramp-Down Rate (T_p to T_L)	6°C / second maximum
Time 25°C to Peak Temperature	8 minutes maximum

JEDEC Moisture Sensitivity

Table 12. Moisture sensitivity levels for LUXEON 3535L Color Line.

LEVEL	FLOOR LIFE		SOAK REQUIREMENTS STANDARD	
	TIME	CONDITIONS	TIME	CONDITIONS
2	1 Year	≤30°C / 60% RH	168 Hours +5 / -0	≤85°C / 60% RH

Solder Pad Design

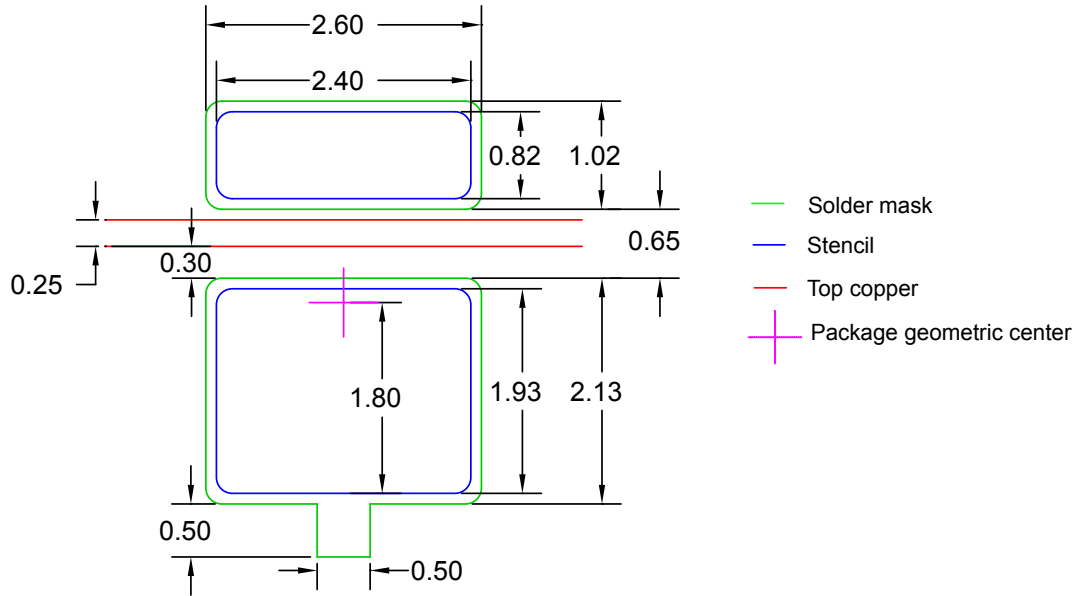

Figure 11. Recommended PCB solder pad layout for LUXEON 3535L Color Line.

Notes for Figure 11:

1. Drawings are not to scale.
2. All dimensions are in millimeters.

Packaging Information

Pocket Tape Dimensions

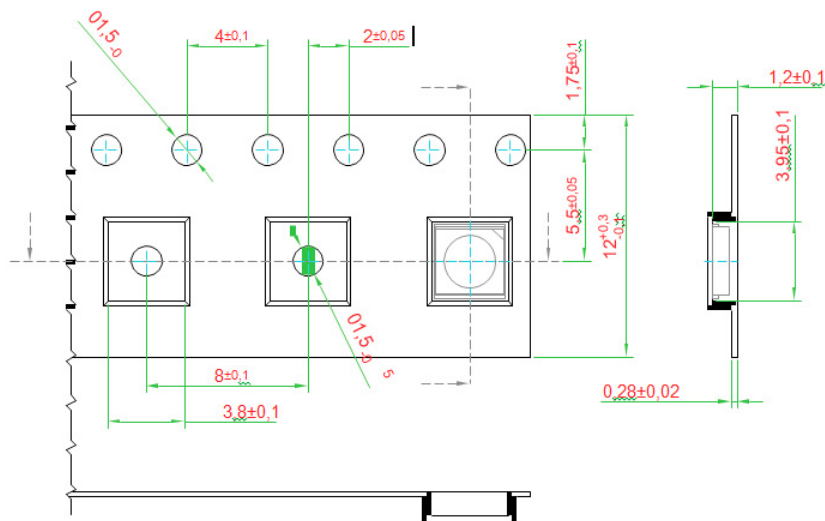

Figure 12. Pocket Tape dimensions for LUXEON 3535L Color Line.

Notes for Figure 12:

1. Drawings are not to scale.
2. All dimensions are in millimeters.
3. Empty components pockets sealed with top cover tape.

Reel Dimensions

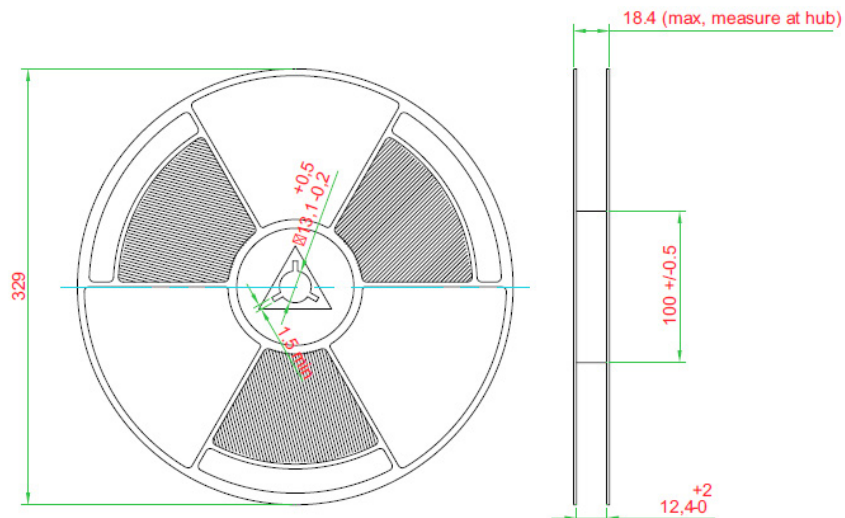

Figure 13. Reel dimensions for LUXEON 3535L Color Line.

Notes for Figure 13:

1. Drawings are not to scale.
2. All dimensions are in millimeters.
3. Empty component pockets sealed with top cover tape.
4. 329 mm reel — 5000 pieces per reel.
5. Minimum packing quantity is 5000 pieces.
6. The maximum number of consecutive missing LEDs is two.
7. In accordance with EIA-481-1-B specification.

About Lumileds

Companies developing automotive, mobile, IoT and illumination lighting applications need a partner who can collaborate with them to push the boundaries of light. With over 100 years of inventions and industry firsts, Lumileds is a global lighting solutions company that helps customers around the world deliver differentiated solutions to gain and maintain a competitive edge. As the inventor of Xenon technology, a pioneer in halogen lighting and the leader in high performance LEDs, Lumileds builds innovation, quality and reliability into its technology, products and every customer engagement. Together with its customers, Lumileds is making the world better, safer, more beautiful—with light.

To learn more about our lighting solutions, visit lumileds.com.



©2018 Lumileds Holding B.V. All rights reserved.
LUXEON is a registered trademark of the Lumileds Holding B.V. in the United States and other countries.
lumileds.com

Neither Lumileds Holding B.V. nor its affiliates shall be liable for any kind of loss of data or any other damages, direct, indirect or consequential, resulting from the use of the provided information and data. Although Lumileds Holding B.V. and/or its affiliates have attempted to provide the most accurate information and data, the materials and services information and data are provided "as is," and neither Lumileds Holding B.V. nor its affiliates warrants or guarantees the contents and correctness of the provided information and data. Lumileds Holding B.V. and its affiliates reserve the right to make changes without notice. You as user agree to this disclaimer and user agreement with the download or use of the provided materials, information and data. A listing of Lumileds product/patent coverage may be accessed at lumileds.com/patents.