

SnapLED 150

Introduction

Using Philips Lumileds' patented solderless clinch technology, SnapLED 150 emitters are attached to a formable metal substrate that offers both styling flexibility and ruggedness unmatched by any other LED assembly.

Automotive lamp makers can now take advantage of Philips Lumileds' performance stability across a wide current range with a SnapLED 150 option that is optimized and binned for use in dual-mode drive current situations such as Automotive Stop/Tail applications using cost-effective resistor-diode drive circuits.

SnapLED's brilliant luminance, flexibility, and reliability enable distinctive and durable lighting designs for vehicles, signals, and specialty lighting.

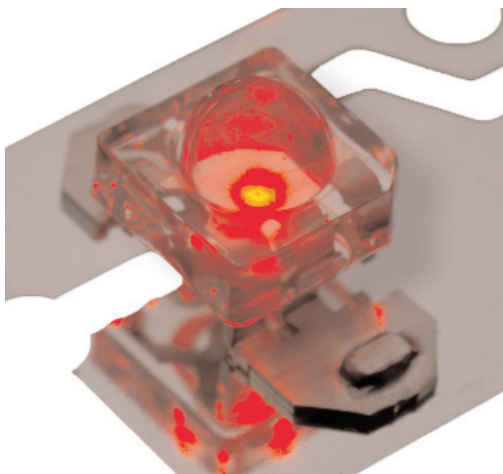

HPWS-TH00
HPWS-FH00
HPWS-TH77
HPWS-FH77
HPWS-TL00
HPWS-FL00

Key Benefits

- ◆ Rugged Lighting Products
- ◆ Electricity Savings
- ◆ Maintenance Savings
- ◆ 3-Dimensional Array Design
- ◆ Environmental Conformance

Features

- ◆ High Luminance
- ◆ Low Power Consumption
- ◆ Low Thermal Resistance
- ◆ Low Profile
- ◆ Solderless Mounting Technique
- ◆ Formable Substrate
- ◆ Meets SAE/ECE/JIS Automotive Color Requirements
- ◆ Packaged in tubes for use with automatic assembly equipment
- ◆ Lead-Free
- ◆ RoHS Compliant
- ◆ Dual-Mode (Stop/Tail) Option

Typical Applications

- ◆ Automotive Lighting
 - Rear Combination Lamps
 - Front Turn Signal Lamps
 - High Mount Stop Lamps
 - Indirect Lighting
- ◆ Solid State Lighting and Signaling

Selection Guide

Table 1

Part Number	Drive Current	LED Color	Total Flux Φ_V (lm)	Total Included Angle	Viewing Angle
			@ 150 mA ⁽¹⁾	$\theta_{0.90V}$ (Degrees) ⁽²⁾	$2\theta^{1/2}$ (Degrees)
			Typ.	Typ.	Typ.
HPWS-TH00	Single Mode	TS AlInGaP Red-Orange	11.0	120	85
HPWS-FH00	Single Mode			70	30
HPWS-TH77	Dual Mode			120	85
HPWS-FH77	Dual Mode			70	30
HPWS-TL00	Single Mode	TS AlInGaP Amber	5.5	120	85
HPWS-FL00	Single Mode			70	30

Notes for Table 1:

- Φ_V is the total luminous flux output as measured with an integrating sphere after the device has stabilized. ($R_{\theta_{J-A}} = 100^\circ\text{C/W}$, $T_A = 25^\circ\text{C}$, $T_j \sim 60^\circ\text{C}$.)
- $\theta_{0.90V}$ is the included angle at which 90% of the total luminous flux is captured. See Figure 5.

Outline Drawings

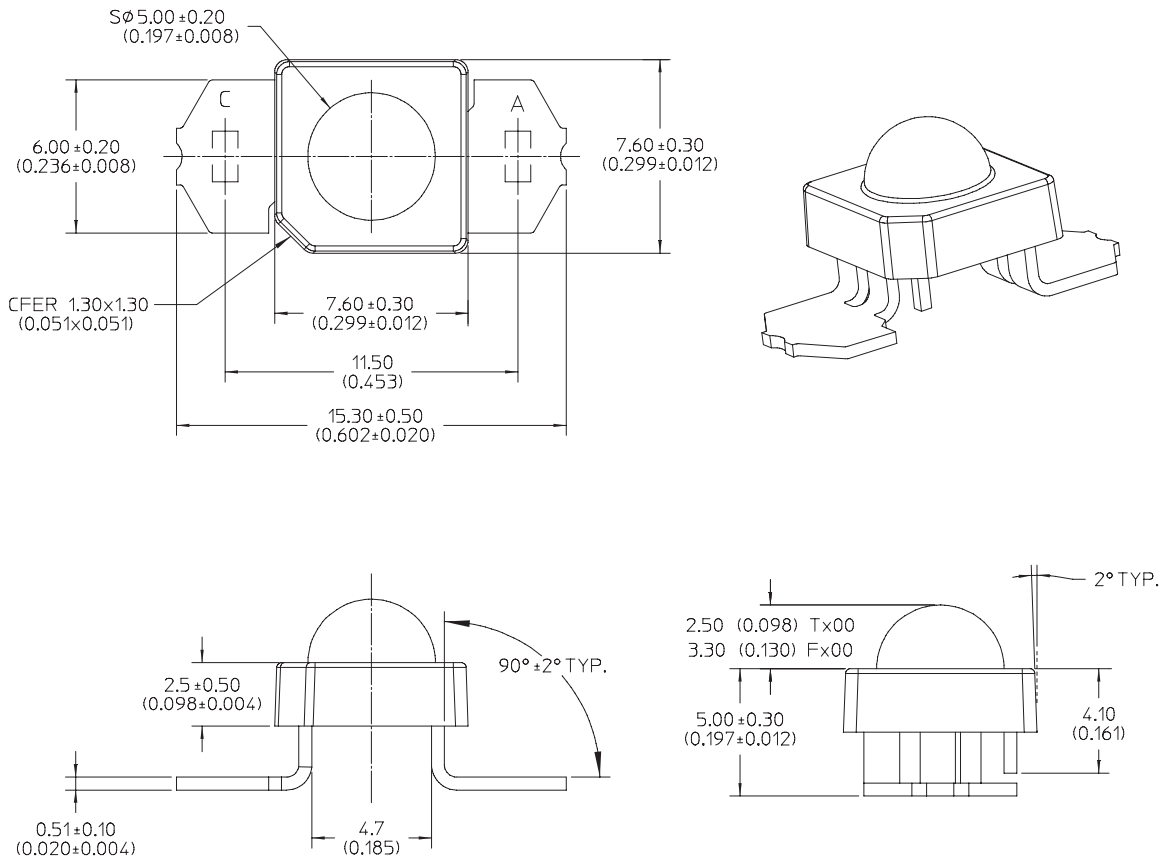

Notes:

- Dimensions are in millimeters (inches).
- Dimensions without tolerances are nominal.
- Cathode lead is indicated with a "C" and anode lead is indicated with an "A."
- Clinch joint locations shown in dashed lines on top view of part (11.50 mm spacing).

Absolute Maximum Ratings at $T_A = 25^\circ\text{C}$

Table 2

Parameter	Rating	Units
DC Forward Current ^[1,2]	150	mA
Pulsed Forward Current ^[3]	200	mA
Minimum DC Forward Current ^[1]	5	mA
Power Dissipation	473	mW
Reverse Voltage ($I_R = 100 \mu\text{A}$)	10	V
Operating Temperature Range	-40 to +100	$^\circ\text{C}$
Storage Temperature Range	-55 to +110	$^\circ\text{C}$
High Temperature Chamber	125 (2 hrs.)	$^\circ\text{C}$
LED Junction Temperature (T_j)	125	$^\circ\text{C}$

Notes for Table 2:

1. Operation at drive currents below 20 mA is recommended only with dual-mode specified LEDs.
2. Derate linearly as shown in Figure 3a.
3. Derate linearly as shown in Figure 3b.

Optical Characteristics at $T_A = 25^\circ\text{C}$ $I_F = 150 \text{ mA}$, $R_{\theta\text{J-A}} = 100^\circ\text{C/W}$

Table 3

Device Type	Total Stabilized Flux Φ_V (lm) ^[1] Typ.	Total Instantaneous Flux Φ_V (lm) ^[2] Typ.	Ratio of Luminous Intensity to Total Flux $I_V(\text{cd})/\Phi_V(\text{lm})$ Typ.	Color, Dominant Wavelength λ_d (nm) ^[3] Typ.	Total Included Angle $\theta_{0.90 V}$ (Degrees) ^[4] Typ.	Peak Wavelength λ_{peak} (nm) ^[3] Typ.	Viewing Angle $2\theta^{1/2}$ (Degrees) Typ.
HPWS-THXX	11.0	12.4	0.6	620	120	632	85
HPWS-FHXX			2.0		70		30
HPWS-TL00	5.5	7.2	0.6	594	120	597	85
HPWS-FL00			2.0		70		30

Notes for Table 3:

1. Total Stabilized Flux Φ_V is the total luminous flux output as measured with an integrating sphere after the device has stabilized to $T_j \sim 60^\circ\text{C}$.
2. Total Instantaneous Flux Φ_V is the total luminous flux output as measured with an integrating sphere at 20ms duration.
3. The dominant wavelength is derived from the CIE Chromaticity Diagram and represents the perceived color of the device at $T_j \sim 60^\circ\text{C}$.
4. $\theta_{0.90 V}$ is the included angle at which 90% of the total luminous flux is captured. See Figure 5.

Electrical Characteristics at $T_A=25^\circ\text{C}$

Table 4

Device Type	Forward Voltage V_F (Volts) @ $I_F = 150\text{mA}$			Reverse Breakdown V_R (Volts) @ $I_R = 100\ \mu\text{A}$		Capacitance C (pF) $V_F = 0, F = 1\text{MHz.}$	Thermal Resistance $R\theta_{J-PIN}$ ($^\circ\text{C/W}$)	Speed of Response τ_s (ns) ^[1]
	Min	Typ	Max	Min	Typ.	Typ.	Typ.	Typ.
HPWS-xHxx	2.19	2.8	3.15	10	20	80	60	20
HPWS-xL00	2.19	2.8	3.15	10	20	80	75	20

Figures^[1]

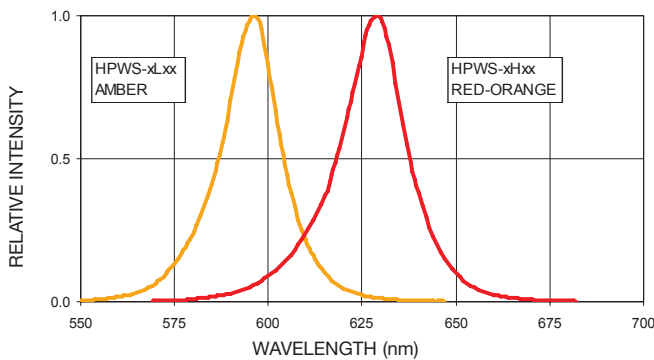

Figure 1. Relative Intensity vs. Wavelength.

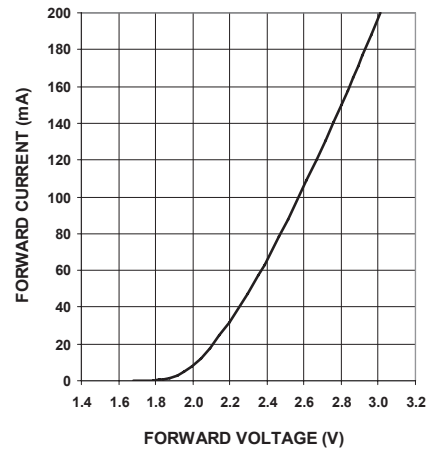

Figure 2. Forward Current vs. Forward Voltage.

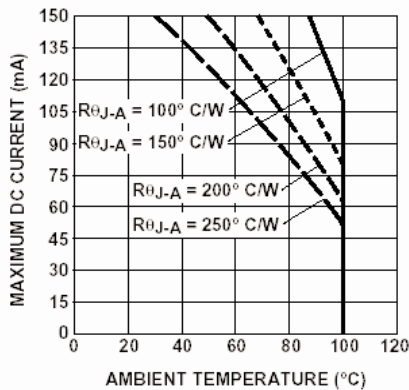

Figure 3a. Maximum DC Forward Current vs. Ambient Temperature.

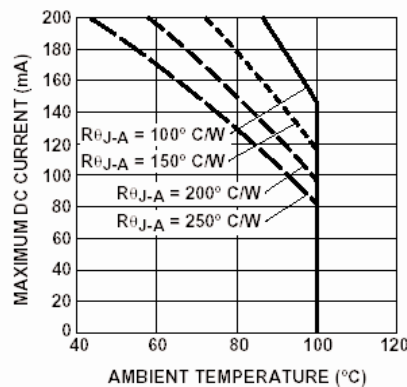

Figure 3b. Maximum Pulsed Forward Current vs. Ambient Temperature.

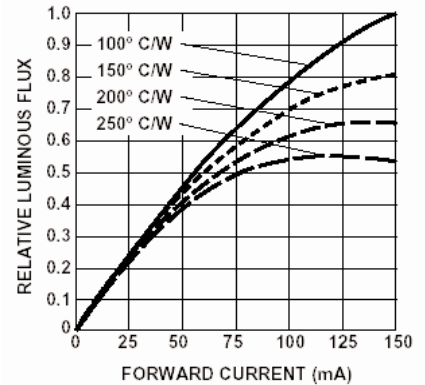

Figure 4. Relative Luminous Flux vs. Forward Current.

1. Figures are Typical unless specified as Maximum.

Figures Continued [1]

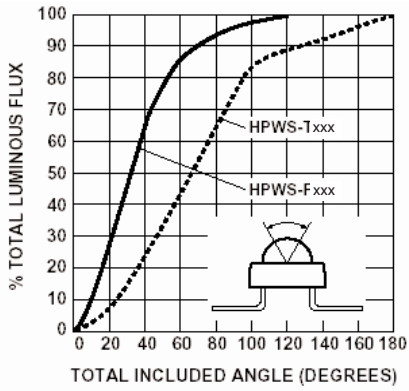

Figure 5. HPWS-xxxx Percent Total Luminous Flux vs. Total Included Angle.

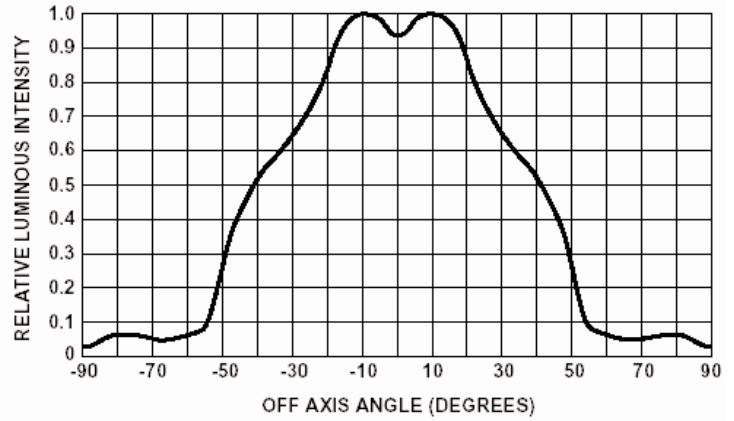

Figure 6a. HPWS-Txxx Relative Intensity vs. Off Axis Angle.

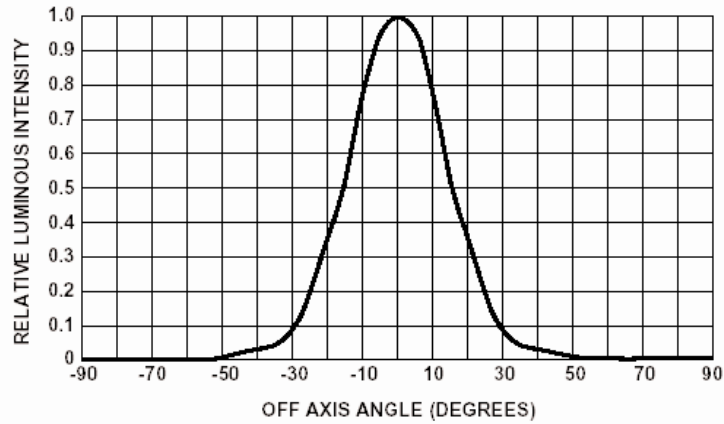

Figure 6b. HPWS-Fxxx Relative Intensity vs. Off Axis Angle.

Notes for Figures:

1. Figures are Typical unless specified as Maximum.
2. For additional information, please refer to the Philips Lumileds AB20 Series of Application Briefs.

SnapLED 150 Product Binning

This section provides bin selection assistance for SnapLED 150 LEDs. Additional category and label details for SnapLED product can be found in AB20-7. Product availability varies by color and other factors, and not all bin-selection combinations are available. Contact your Philips Lumileds representative for further assistance.

Luminous Flux Bins

Part Number	Bin Code	High Drive Current (150mA)		Low Drive Current ⁽¹⁾ (10mA)	
		Minimum Luminous Flux ⁽²⁾ (lm)	Maximum Luminous Flux ⁽²⁾ (lm)	Minimum Luminous Flux (lm)	Maximum Luminous Flux (lm)
HPWS-FL00 HWPS-TL00	F	3.00	4.20	N/A	N/A
	G	3.50	4.80	N/A	N/A
	H	4.00	6.10	N/A	N/A
	J	5.00	7.30	N/A	N/A
	L	6.00	9.70	N/A	N/A
HPWS-FH00 HWPS-TH00	L	6.00	9.70	N/A	N/A
	M	8.00	12.00	N/A	N/A
	N	10.00	16.00	N/A	N/A
HPWS-FH77 HWPS-TH77	P	13.00	21.00	N/A	N/A
	U	7.20	11.40	0.50	0.97
	V	9.40	14.10	0.63	1.19
	W	11.50	16.70	0.79	1.43

Note:

1. Dual-Mode Drive Current option applies to HPWS-xH77 product only.
2. Total Luminous Flux at 150mA as measured with an integrating sphere after the device has stabilized. $T_j \sim 60^\circ\text{C}$

Dominant Wavelength Bins, Red-Orange

Bin Code	Minimum Dominant Wavelength (nm)	Maximum Dominant Wavelength (nm)
1	611	617
2	615	621
3	619	629

Dominant Wavelength Bins, Amber

Bin Code	Minimum Dominant Wavelength (nm)	Maximum Dominant Wavelength (nm)
1	587	591
2	589	594
9	592	595
3	592	597

Forward Voltage Bins, High Current (150 mA)

Bin Code	Minimum Voltage	Maximum Voltage
1	2.19	2.43
2	2.31	2.55
3	2.43	2.67
4	2.55	2.79
5	2.67	2.91
6	2.79	3.03
7	2.91	3.15

Forward Voltage Bins, Low Current¹ (10 mA)

Bin Code	Minimum Voltage	Maximum Voltage
B	1.84	1.94
C	1.90	2.00
D	1.96	2.06
E	2.02	2.12
F	2.08	2.18
G	2.14	2.24
H	2.20	2.30

1. Low Current V_f Binning applies to HPWS-xH77 Dual-Mode product only.



Company Information

Philips Lumileds is a world-class supplier of Light Emitting Diodes (LEDs) producing billions of LEDs annually. Philips Lumileds is a fully integrated supplier, producing core LED material in all three base colors (Red, Green, Blue) and White. Philips Lumileds has R&D centers in San Jose, California and in The Netherlands and production capabilities in San Jose and Penang, Malaysia. Founded in 1999, Philips Lumileds is the high-flux LED technology leader and is dedicated to bridging the gap between solid-state LED technology and the lighting world. Philips Lumileds technology, LEDs and systems are enabling new applications and markets in the lighting world.

Philips Lumileds may make process or materials changes affecting the performance or other characteristics of our products. These products supplied after such changes will continue to meet published specifications, but may not be identical to products supplied as samples or under prior orders.



WWW.LUXEON.COM
WWW.LUMILEDSFUTURE.COM

FOR TECHNICAL ASSISTANCE OR THE LOCATION OF YOUR NEAREST SALES OFFICE CONTACT ANY OF THE FOLLOWING:

NORTH AMERICA:
1 888 589 3662
AMERICAS@FUTURELIGHTINGSOLUTIONS.COM

EUROPE:
OO 800 443 88 873
EUROPE@FUTURELIGHTINGSOLUTIONS.COM

ASIA PACIFIC:
800 5864 5337
ASIA@FUTURELIGHTINGSOLUTIONS.COM

JAPAN:
800 5864 5337
JAPAN@FUTURELIGHTINGSOLUTIONS.COM

©2007 Philips Lumileds Lighting Company. All rights reserved. Product specifications are subject to change without notice. Luxeon is a registered trademark of the Philips Lumileds Lighting Company in the United States and other countries.